



LIGHTING FOREVER

# 4 PIN DIP PHOTOTRANSISTOR PHOTOCOUPLER

## EL817 Series

### Features:

- Current transfer ratio (CTR: 50~600% at  $I_F = 5\text{mA}$ ,  $V_{CE} = 5\text{V}$ )
- High isolation voltage between input and output ( $V_{iso} = 5000\text{ V rms}$ )
- Creepage distance  $> 7.62\text{ mm}$
- Operating temperature up to  $+110^\circ\text{C}$
- Compact small outline package
- Pb free and RoHS compliant.
- UL approved (No. E214129)
- VDE approved (No. 132249)
- SEMKO approved (No. 716108)
- NEMKO approved (No. P08209467)
- DEMKO approved (No. 314683)
- FIMKO approved (No. FI 224433)
- CSA approved (No. 1143601)

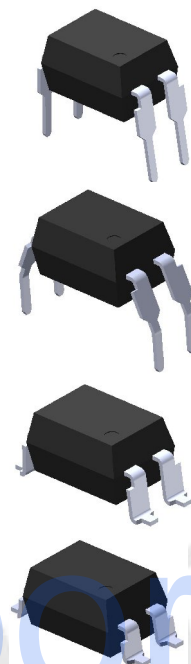

### Description

The EL817 series of devices each consist of an infrared emitting diodes, optically coupled to a phototransistor detector.

They are packaged in a 4-pin DIP package and available in wide-lead spacing and SMD option.

### Applications

- Programmable controllers
- System appliances, measuring instruments
- Telecommunication equipments
- Home appliances, such as fan heaters, etc.
- Signal transmission between circuits of different potentials and impedances

### Schematic

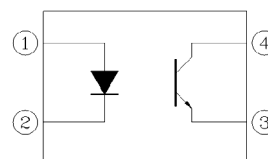

### Pin Configuration

1. Anode
2. Cathode
3. Emitter
4. Collector



LIGHTING FOREVER

## 4 PIN DIP PHOTOTRANSISTOR PHOTOCOUPLER

**EL817 Series****Absolute Maximum Ratings ( $T_a=25^{\circ}\text{C}$ )**

Parameter		Symbol	Rating	Unit
Input	Forward current	$I_F$	60	mA
	Peak forward current (1us, pulse)	$I_{FP}$	1	A
	Reverse voltage	$V_R$	6	V
	Power dissipation	$P_D$	100	mW
	Derating factor ( above $T_a = 100^{\circ}\text{C}$ )		2.9	mW/ $^{\circ}\text{C}$
Output	Power dissipation	$P_C$	150	mW
	Derating factor (above $T_a = 100^{\circ}\text{C}$ )		5.8	mW/ $^{\circ}\text{C}$
	Collector current	$I_C$	50	mA
	Collector-Emitter voltage	$V_{CEO}$	35	V
	Emitter-Collector voltage	$V_{ECO}$	6	V
Total power dissipation		$P_{TOT}$	200	mW
Isolation voltage <sup>*1</sup>		$V_{ISO}$	5000	V rms
Operating temperature		$T_{OPR}$	-55 ~ +110	$^{\circ}\text{C}$
Storage temperature		$T_{STG}$	-55 ~ +125	$^{\circ}\text{C}$
Soldering temperature <sup>*2</sup>		$T_{SOL}$	260	$^{\circ}\text{C}$

**Notes**

\*1 AC for 1 minute, R.H.= 40 ~ 60% R.H. In this test, pins 1 & 2 are shorted together, and pins 3 & 4 are shorted together.

\*2 For 10 seconds.



LIGHTING FOREVER

# 4 PIN DIP PHOTOTRANSISTOR PHOTOCOUPLER

## EL817 Series

### Electrical Characteristics (T<sub>a</sub>=25°C unless specified otherwise)

#### Input

Parameter	Symbol	Min.	Typ.*	Max.	Unit	Condition
Forward voltage	V <sub>F</sub>	-	1.2	1.4	V	I <sub>F</sub> = 20mA
Reverse current	I <sub>R</sub>	-	-	10	μA	V <sub>R</sub> = 4V
Input capacitance	C <sub>in</sub>	-	30	250	pF	V = 0, f = 1kHz

#### Output

Parameter	Symbol	Min.	Typ.*	Max.	Unit	Condition
Collector-Emitter dark current	I <sub>CEO</sub>	-	-	100	nA	V <sub>CE</sub> = 20V, I <sub>F</sub> = 0mA
Collector-Emitter breakdown voltage	BV <sub>CEO</sub>	35	-	-	V	I <sub>C</sub> = 0.1mA
Emitter-Collector breakdown voltage	BV <sub>ECO</sub>	6	-	-	V	I <sub>E</sub> = 0.1mA

### Transfer Characteristics (T<sub>a</sub>=25°C unless specified otherwise)

Parameter	Symbol	Min.	Typ.*	Max.	Unit	Condition
Current Transfer ratio	EL817	50	-	600	%	I <sub>F</sub> = 5mA, V <sub>CE</sub> = 5V
	EL817A	80	-	160		
	EL817B	130	-	260		
	EL817C	200	-	400		
	EL817D	300	-	600		
	EL817X	100	-	200		
	EL817Y	150	-	300		
Collector-Emitter saturation voltage	V <sub>CE(sat)</sub>	-	0.1	0.2	V	I <sub>F</sub> = 20mA, I <sub>C</sub> = 1mA
Isolation resistance	R <sub>IO</sub>	5×10 <sup>10</sup>	-	-	Ω	V <sub>IO</sub> = 500Vdc, 40~60% R.H.
Floating capacitance	C <sub>IO</sub>	-	0.6	1.0	pF	V <sub>IO</sub> = 0, f = 1MHz
Cut-off frequency	f <sub>c</sub>	-	80	-	kHz	V <sub>CE</sub> = 5V, I <sub>C</sub> = 2mA R <sub>L</sub> = 100Ω, -3dB
Rise time	t <sub>r</sub>	-	4	18	μs	V <sub>CE</sub> = 2V, I <sub>C</sub> = 2mA, R <sub>L</sub> = 100Ω
Fall time	t <sub>f</sub>	-	3	18	μs	

\* Typical values at T<sub>a</sub> = 25°C

# 4 PIN DIP PHOTOTRANSISTOR PHOTOCOUPLER

## EL817 Series

### Typical Performance Curves

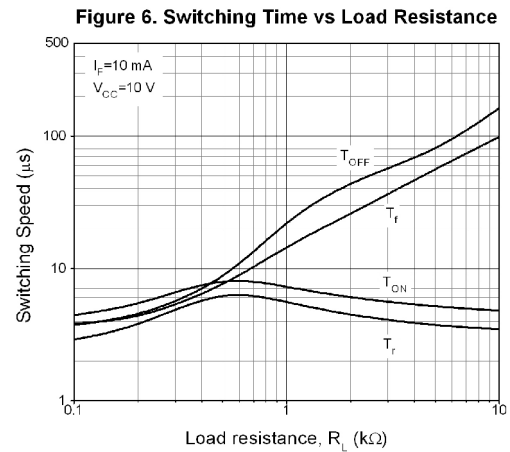
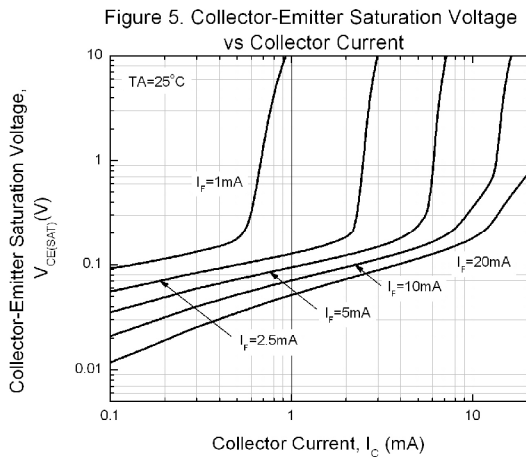
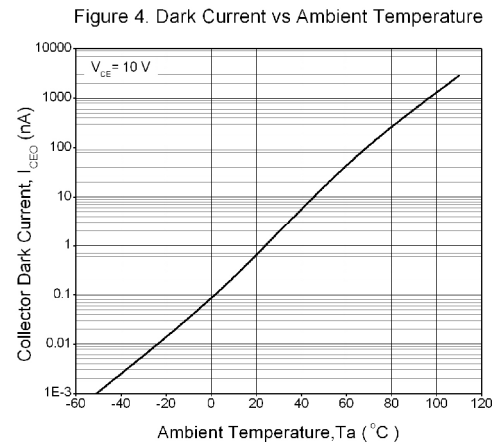
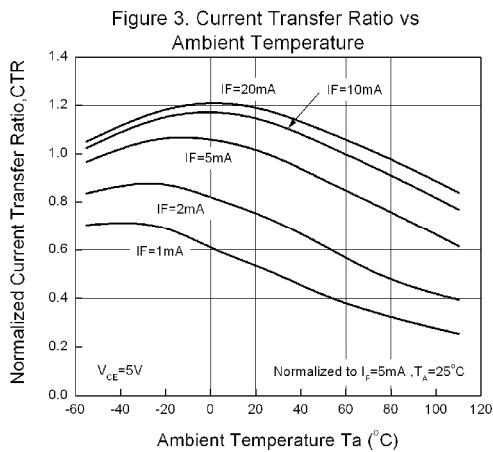
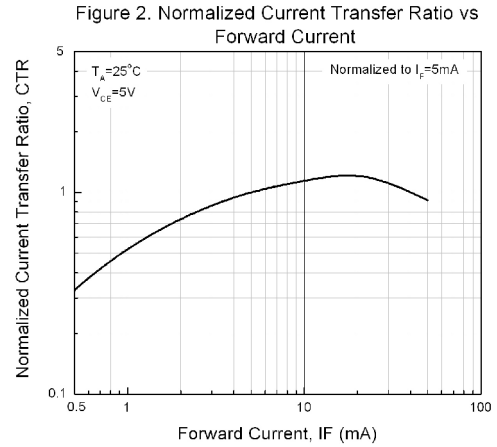
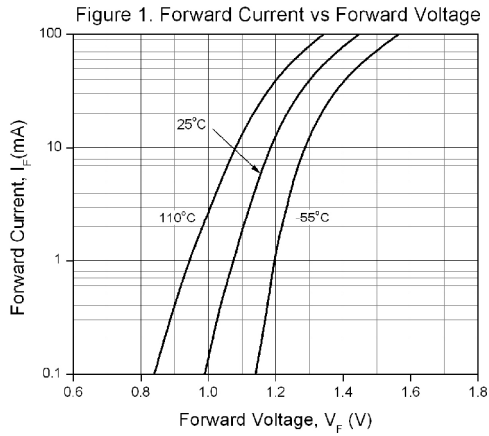

**4 PIN DIP PHOTOTRANSISTOR  
PHOTOCOUPLER**

**EL817 Series**

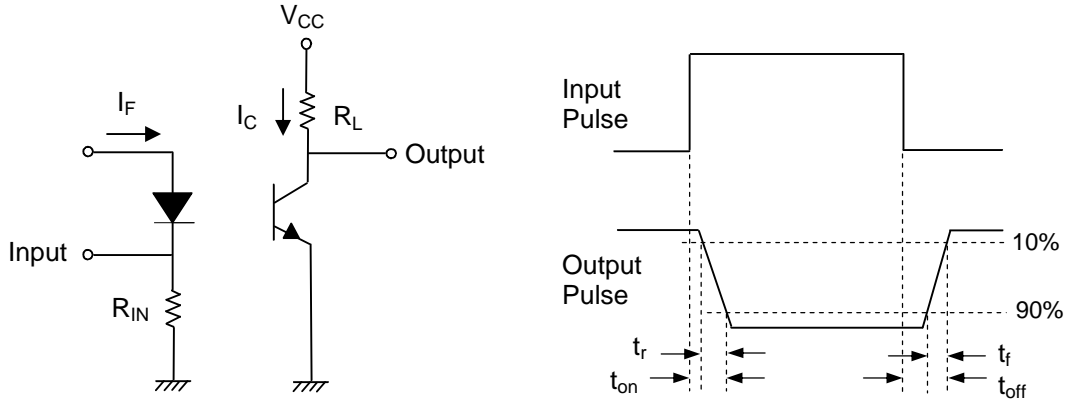

**Figure 7. Switching Time Test Circuit & Waveforms**

EVERLIGHT



LIGHTING FOREVER

# 4 PIN DIP PHOTOTRANSISTOR PHOTOCOUPLER

## EL817 Series

### Order Information

#### Part Number

# EL817(X)(Y)(Z)-FV

#### Note

- X = Lead form option (S, S1, S2, M or none)
- Y = CTR Rank (A, B, C, D, X, Y or none)
- Z = Tape and reel option (TA, TB, TU, TD or none).
- F = Lead frame option (F: Iron, None: copper)
- V = VDE safety (optional).

Option	Description	Packing quantity
None	Standard DIP-4	100 units per tube
M	Wide lead bend (0.4 inch spacing)	100 units per tube
S (TA)	Surface mount lead form + TA tape & reel option	1000 units per reel
S (TB)	Surface mount lead form + TB tape & reel option	1000 units per reel
S1 (TA)	Surface mount lead form (low profile) + TA tape & reel option	1000 units per reel
S1 (TB)	Surface mount lead form (low profile) + TB tape & reel option	1000 units per reel
S2 (TA)	Surface mount lead form (Gull-wing) + TA tape & reel option	500 units per reel
S2 (TB)	Surface mount lead form (Gull-wing) + TB tape & reel option	500 units per reel
S (TU)	Surface mount lead form + TU tape & reel option	1500 units per reel
S (TD)	Surface mount lead form + TD tape & reel option	1500 units per reel
S1 (TU)	Surface mount lead form (low profile) + TU tape & reel option	1500 units per reel
S1 (TD)	Surface mount lead form (low profile) + TD tape & reel option	1500 units per reel

# 4 PIN DIP PHOTOTRANSISTOR PHOTOCOUPLER

**EL817 Series**

## Package Drawing (Dimensions in mm)

### Standard DIP Type

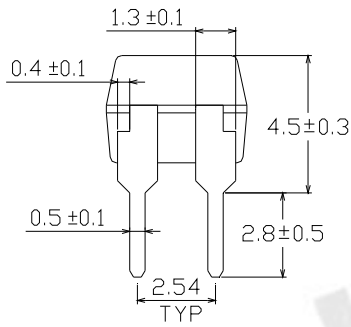
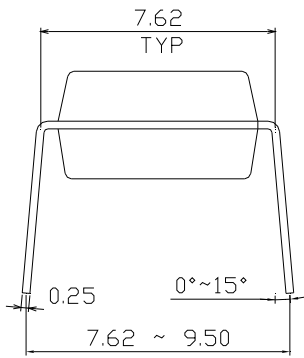
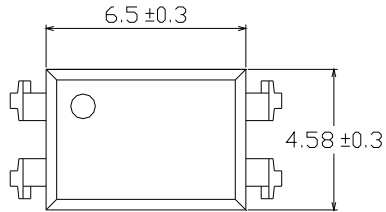

### Option M Type

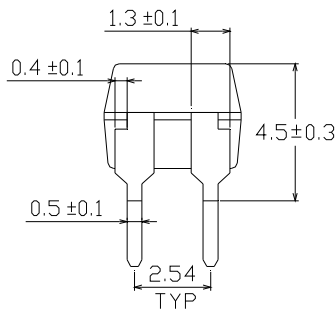
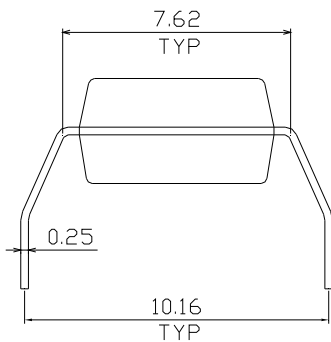
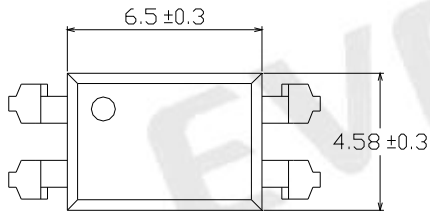



LIGHTING FOREVER

# 4 PIN DIP PHOTOTRANSISTOR PHOTOCOUPLER

## EL817 Series

### Option S Type

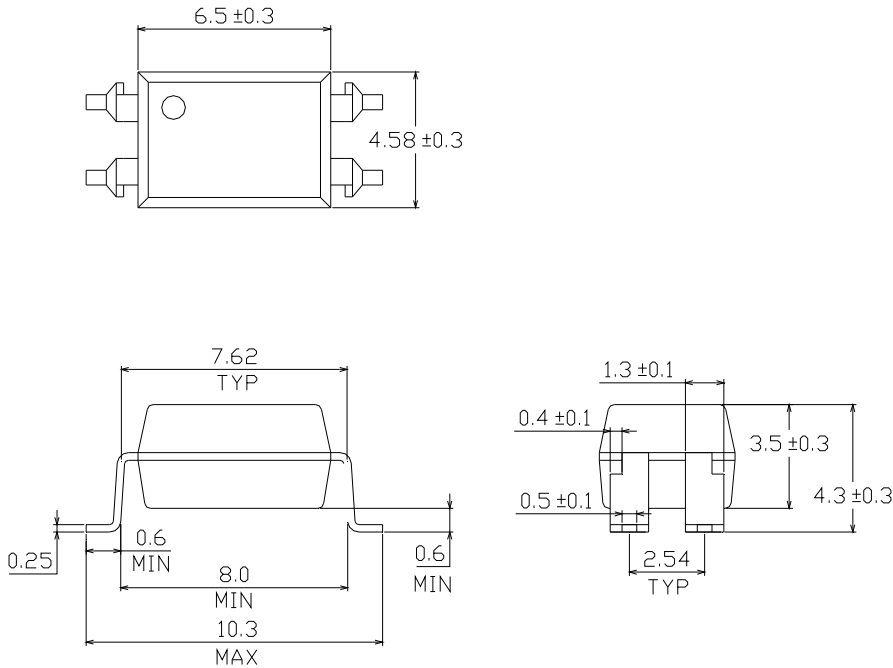

### Option S1 Type

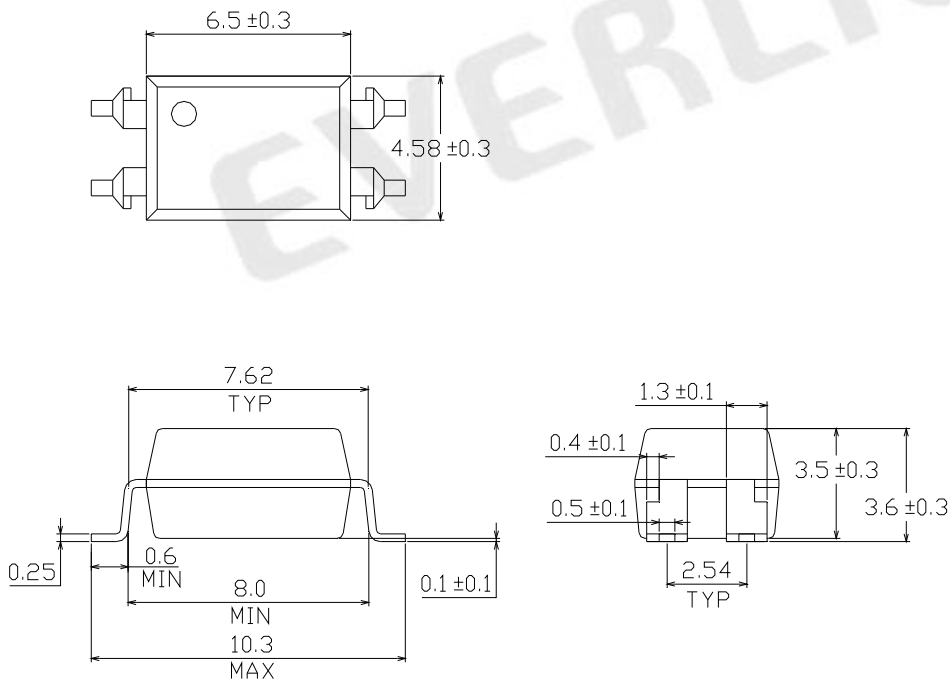





LIGHTING FOREVER

# 4 PIN DIP PHOTOTRANSISTOR PHOTOCOUPLER

## EL817 Series

### Option S2 Type

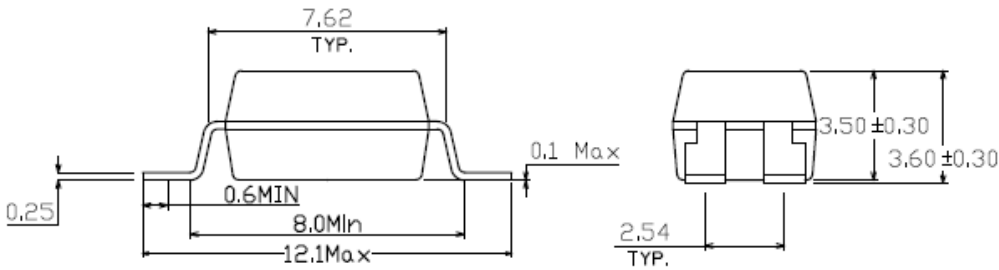
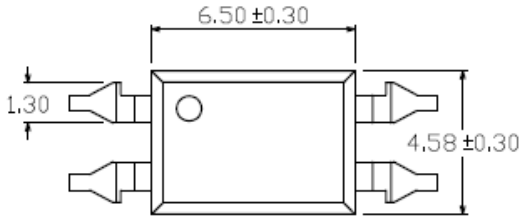

### Recommended pad layout for surface mount leadform

For S and S1 option

For S2 option

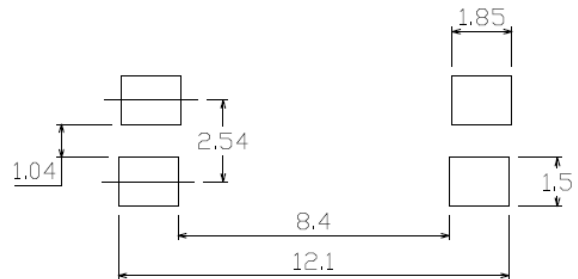
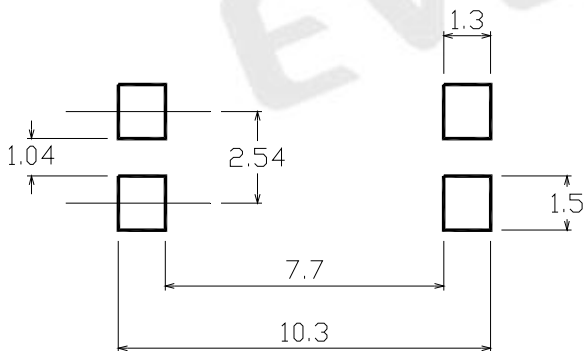



LIGHTING FOREVER

# 4 PIN DIP PHOTOTRANSISTOR PHOTOCOUPLER

## EL817 Series

### Device Marking

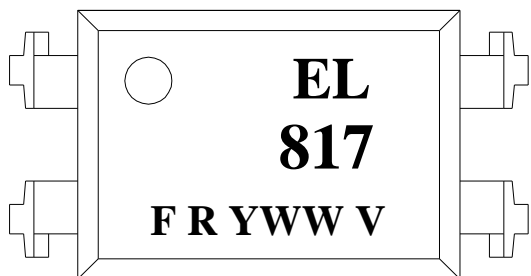

### Notes

EL denotes EVERLIGHT  
817 denotes Device Number  
F denotes Factory Code (None: China, T: Taiwan)  
R denotes CTR Rank (A, B, C, D or none)  
Y denotes 1 digit Year code  
WW denotes 2 digit Week code  
V denotes VDE (optional)

EVERLIGHT

# 4 PIN DIP PHOTOTRANSISTOR PHOTOCOUPLER

## EL817 Series

### Tape & Reel Packing Specifications

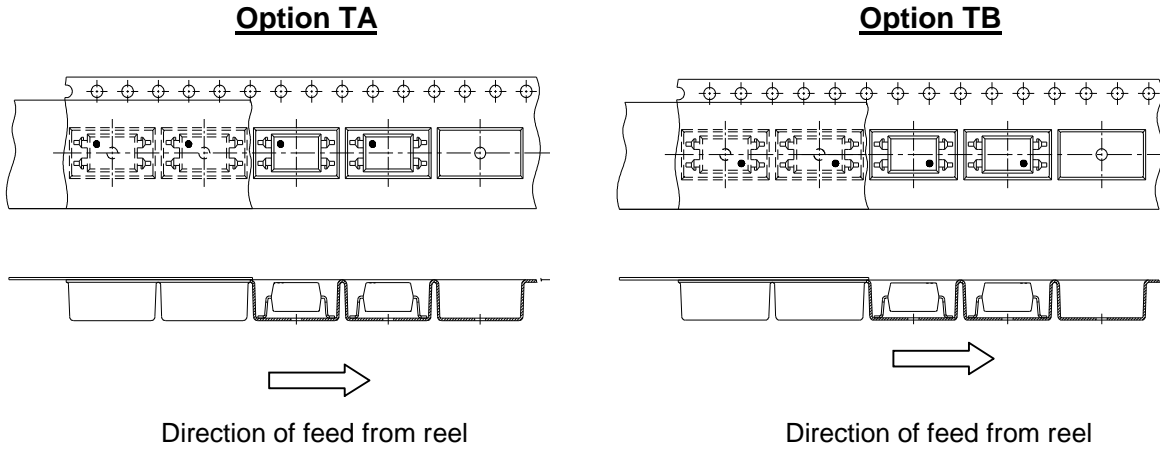

### Tape dimensions

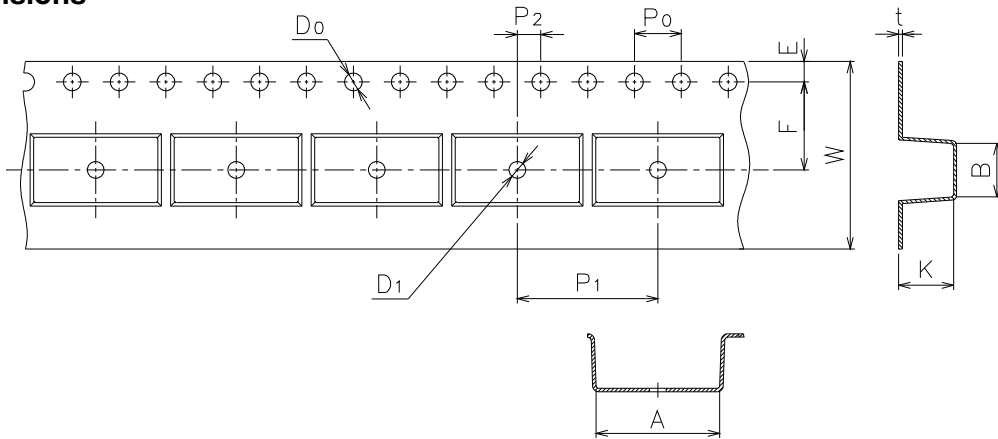

Dimension No.	A	B	Do	D1	E	F
For S2 type						
Dimension(mm)	12.15±0.1	4.65±0.1	1.55±0.1	1.5±0.05	1.75±0.1	7.5±0.1
Dimension(mm)	10.4±0.1	4.55±0.1	1.5±0.1	1.5±0.05	1.75±0.1	7.5±0.1
Dimension No.	Po	P1	P2	t	W	K
For S2 type						
Dimension(mm)	4.0±0.1	16.0±0.1	2.0±0.1	0.35±0.1	16.0+0.3/ -0.1	4.55±0.1
Dimension(mm)	4.0±0.1	12.0±0.1	2.0±0.1	0.33±0.1	16.0+0.3/ -0.1	4.55±0.1



LIGHTING FOREVER

# 4 PIN DIP PHOTOTRANSISTOR PHOTOCOUPLER

## EL817 Series

**Option TD**

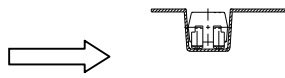
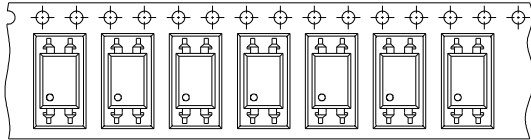

Direction of feed from reel

**Option TU**

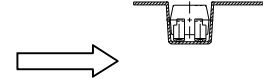
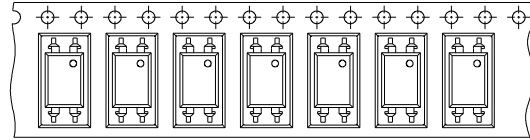

Direction of feed from reel

### Tape dimensions

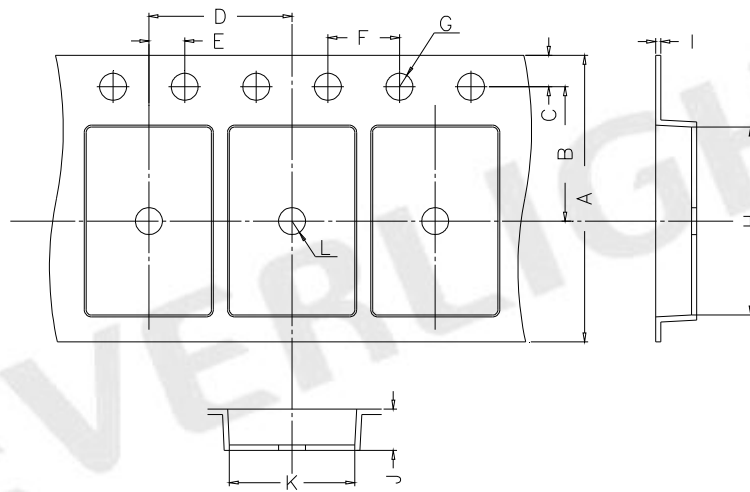

Dimension No.	<b>A</b>	<b>B</b>	<b>C</b>	<b>D</b>	<b>E</b>	<b>F</b>
Dimension(mm)	16.00±0.3	7.5±0.1	1.75±0.1	8.0±0.1	2.0±0.1	4.0±0.1
Dimension No.	<b>G</b>	<b>H</b>	<b>I</b>	<b>J</b>	<b>K</b>	<b>L</b>
Dimension(mm)	1.5+0.1/-0	10.4±0.1	0.4±0.05	4.55±0.1	5.1±0.1	1.5±0.05



LIGHTING FOREVER

# 4 PIN DIP PHOTOTRANSISTOR PHOTOCOUPLER

## EL817 Series

### Solder Reflow Temperature Profile

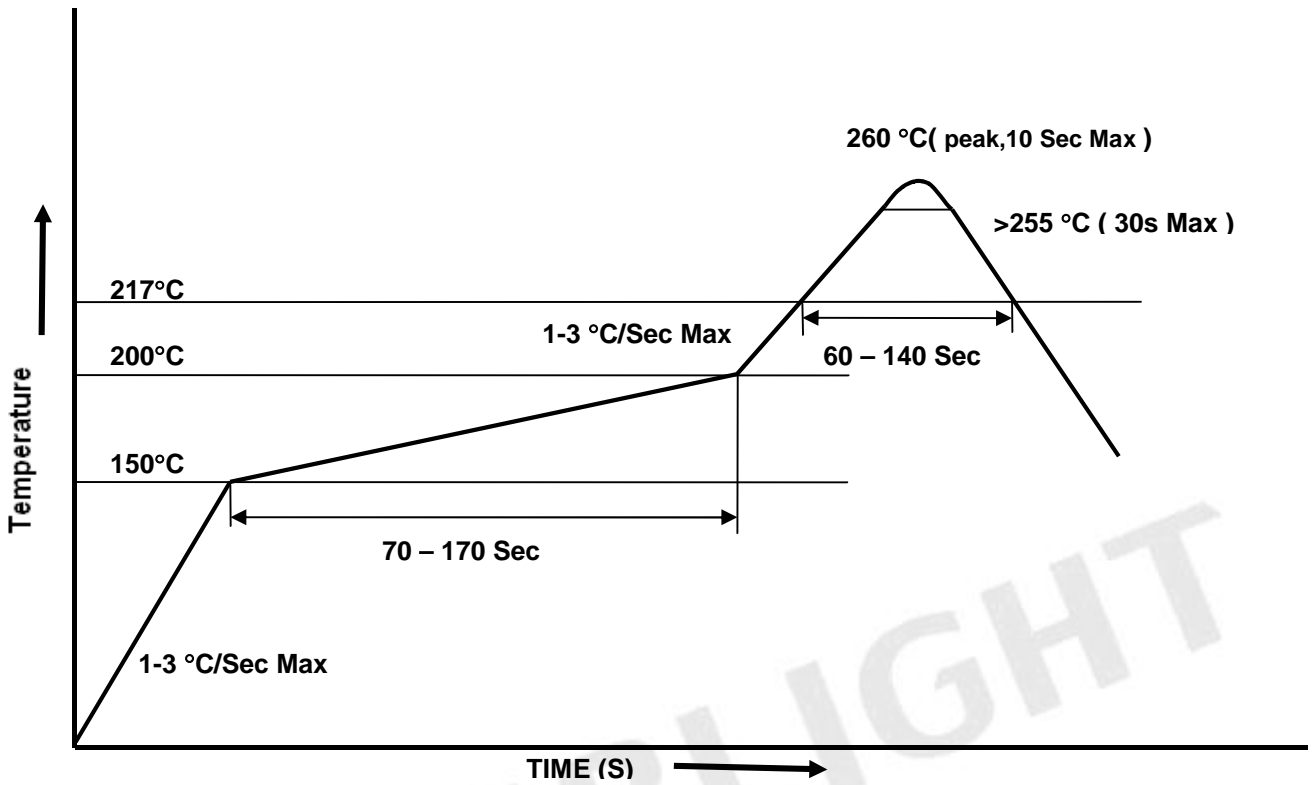



LIGHTING FOREVER

## 4 PIN DIP PHOTOTRANSISTOR PHOTOCOUPLER

**EL817 Series**

---

### DISCLAIMER

1. The specifications in this datasheet may be changed without notice. EVERLIGHT reserves the authority on material change for above specification.
2. When using this product, please observe the absolute maximum ratings and the instructions for use as outlined in this datasheet. EVERLIGHT assumes no responsibility for any damage resulting from use of the product which does not comply with the absolute maximum ratings and the instructions included in this datasheet.
3. These specification sheets include materials protected under copyright of EVERLIGHT. Reproduction in any form is prohibited without the specific consent of EVERLIGHT.

EVERLIGHT