



ITT

Interconnect Solutions
Cannon, VEAM, BIW

Defining innovative
aviation, military, and
industrial circulars since the DC-1,
over 70 years ago



Engineered for life



A

Circular

How To Order

Military Nomenclature

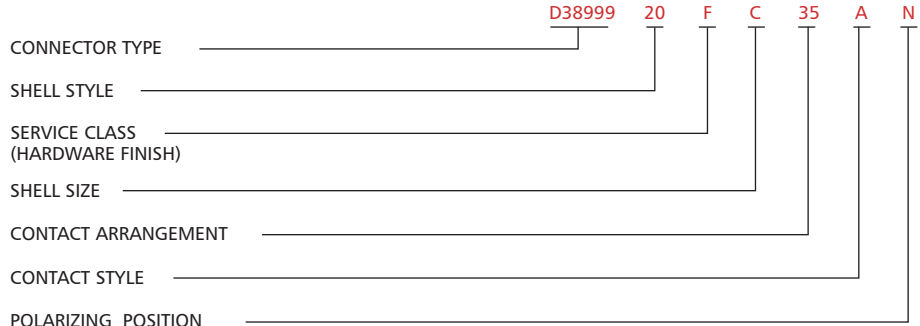

CONNECTOR TYPE
D38999/ - MIL-DTL-38999 Series III

CONTACT ARRANGEMENT
See pages A-24, A-25.

SHELL STYLE
D38999/20 - Wall mount receptacle
D38999/24 - Jam nut receptacle
D38999/26 - Straight Plug, Grounded

CONTACT STYLE
P - Pin contacts
S - Socket contact
A - Less Pin contacts*
B - Less Socket contact*

SERVICE CLASS
(Hardware Finish)
F - Electroless nickel - 85°F to +392°F (-65°C to +200°C)
G - Electroless nickel plated. Space Grade.
W - Olive drab cadmium over electroless nickel plate, -85°F to +347°F (-65°C to +175°C)

* Used only when other than power contacts are to be installed (i.e., shielded, thermocouple, etc.)

POLARIZING POSITION
N (normal), A, B, C, D, E. See page A-23.

Note: To order MS connectors less standard power contacts, purchase order must state "Less Contacts".

SHELL SIZE

										Military Designation
A	B	C	D	E	F	G	H	J		
9	11	13	15	17	19	21	23	25		Cannon Designation

Cannon Nomenclature

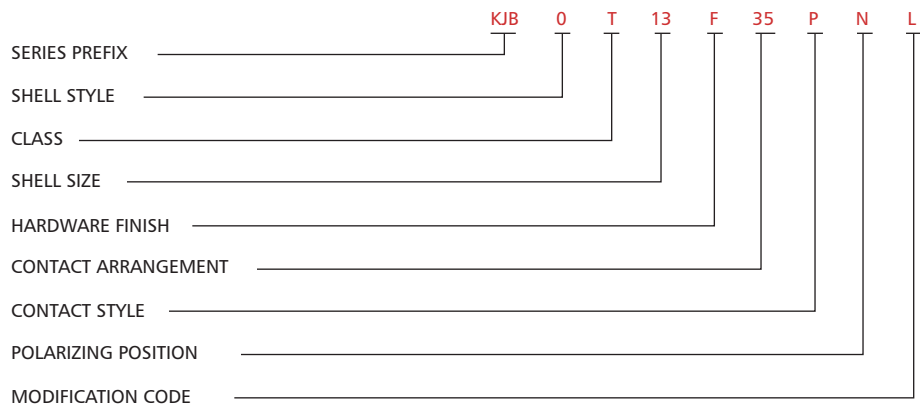

SHELL SIZE

										Cannon Designation
9	11	13	15	17	19	21	23	25		
A	B	C	D	E	F	G	H	J		Military Designation

CONTACT STYLE
P -Pin contacts
S -Socket contacts

SERIES PREFIX
KJA - Series III - Scoop proof, threaded coupling
*KJB - Series III - Scoop proof, threaded coupling, and with plastic contact retention

POLARIZING POSITION
N (normal) A, B, C, D, E. See page A-23.

SHELL STYLE
0 - Wall mount receptacle
6 - Straight plug
7 - Jam nut receptacle

HARDWARE FINISH
F - Electroless nickel, - 85°F to +392°F (-65°C to +200°C)
G - Electroless nickel plated. Space Grade.
W - Olive drab cadmium over electroless nickel plate, -85°F to +347°F (-65°C to +175°C)
Z - Zinc Nickel, Black
- - (Dash) When using a finish modification code

MODIFICATION CODE
L - Less contacts, not stamped on connector
16 - Outgassed NASA space graded connector
27- Outgassed, standard connector
T-69 Olive Drab (Green) Zinc Cobalt

CLASS
T - Environment-resistant (without rear accessory)

CONTACT ARRANGEMENTS
See pages A-24 and A-25.

* Consult factory for applicable layouts





A

Circular

Wall Mount Receptacle

D38999/20

KJA0T

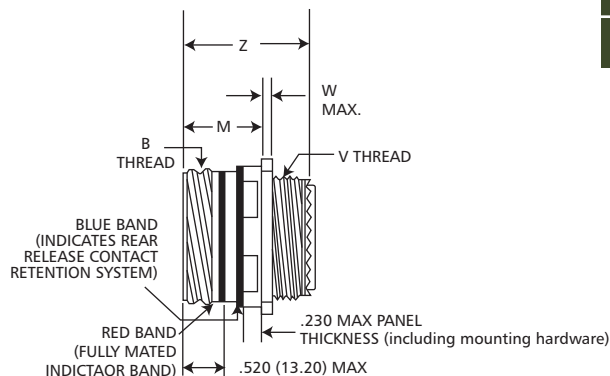
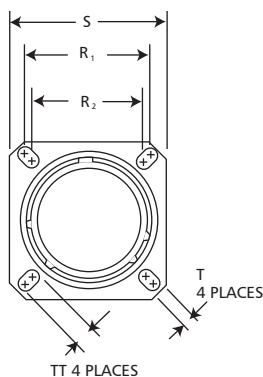

Shell Size	MS Shell size Code	B Thread Class 2A (Plated)	M +.000 (.000) - .005 (.130)	R 1	R 2	S +.004 (.100) - .002 (.050)	T +.004 (.100) - .002 (.050)	TT +.004 (.100) - .002 (.050)	Metric V Thread (Plated)	W Max.	Z +.005 (.130) - .010 (.250)
9	A	.6250-0.1P-0.3L-TS	.820 (20.83)	.719 (18.26)	.594 (15.09)	.938 (23.83)	.128 (3.25)	.216 (5.49)	M12X1-6g0.100R	.098 (2.50)	1.235 (31.36)
11	B	.7500-0.1P-0.3L-TS	.820 (20.83)	.812 (20.62)	.719 (18.26)	1.031 (26.19)	.128 (3.25)	.194 (4.93)	M15X1-6g0.100R	.098 (2.50)	1.235 (31.36)
13	C	.8750-0.1P-0.3L-TS	.820 (20.83)	.906 (23.01)	.812 (20.62)	1.125 (28.58)	.128 (3.25)	.194 (4.93)	M18X1-6g0.100R	.098 (2.50)	1.235 (31.36)
15	D	1.0000-0.1P-0.3L-TS	.820 (20.83)	.969 (24.61)	.906 (23.01)	1.219 (30.96)	.128 (3.25)	.173 (4.39)	M22X1-6g0.100R	.098 (2.50)	1.235 (31.36)
17	E	1.1875-0.1P-0.3L-TS	.820 (20.83)	1.062 (26.97)	.969 (24.61)	1.312 (33.32)	.128 (3.25)	.194 (4.93)	M25X1-6g0.100R	.098 (2.50)	1.235 (31.36)
19	F	1.2500-0.1P-0.3L-TS	.820 (20.83)	1.156 (29.36)	1.062 (26.97)	1.438 (36.53)	.128 (3.25)	.194 (4.93)	M28X1-6g0.100R	.098 (2.50)	1.235 (31.36)
21	G	1.3750-0.1P-0.3L-TS	.790 (20.07)	1.250 (31.75)	1.156 (29.36)	1.562 (39.67)	.128 (3.25)	.194 (4.93)	M31X1-6g0.100R	.126 (3.20)	1.235 (31.36)
23	H	1.5000-0.1P-0.3L-TS	.790 (20.07)	1.375 (34.92)	1.250 (31.75)	1.688 (42.88)	.154 (3.91)	.242 (6.15)	M34X1-6g0.100R	.126 (3.20)	1.235 (31.36)
25	J	1.6250-0.1P-0.3L-TS	.790 (20.07)	1.500 (38.10)	1.375 (34.92)	1.812 (46.02)	.154 (3.91)	.242 (6.15)	M37X1-6g0.100R	.126 (3.20)	1.235 (31.36)

Straight Plug Grounded

D38999/26

KJA6T

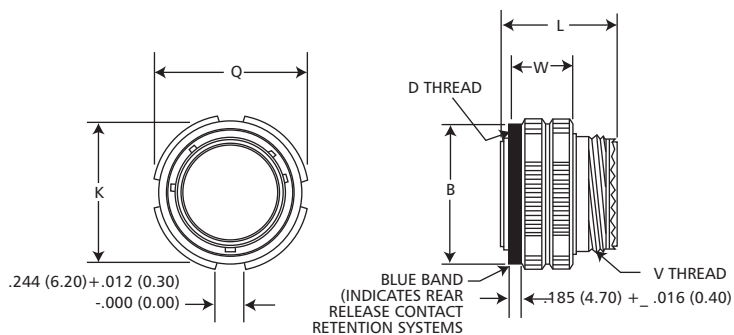

Shell Size	MS Shell size Code	B +.008 (.200) - .000 (.000)	D Thread Class 2B (Plated)	K Max.	L Max.	Q Dia Max.	Metric V Thread (Plated)	W +.008 (.200) - .004 (.100)
9	A	.724 (18.40)	.6250-0.1P-0.3L-TS	.748 (19.00)	1.234 (31.34)	.859 (21.82)	M12X1-6g0.100R	.760 (19.30)
11	B	.831 (21.10)	.7500-0.1P-0.3L-TS	.862 (21.90)	1.234 (31.34)	.969 (24.61)	M15X1-6g0.100R	.760 (19.30)
13	C	1.000 (25.40)	.8750-0.1P-0.3L-TS	1.027 (26.10)	1.234 (31.34)	1.141 (28.98)	M18X1-6g0.100R	.760 (19.30)
15	D	1.130 (28.70)	1.0000-0.1P-0.3L-TS	1.153 (29.30)	1.234 (31.34)	1.266 (32.16)	M22X1-6g0.100R	.760 (19.30)
17	E	1.268 (32.20)	1.1875-0.1P-0.3L-TS	1.291 (32.80)	1.234 (31.34)	1.391 (35.53)	M25X1-6g0.100R	.760 (19.30)
19	F	1.374 (34.90)	1.2500-0.1P-0.3L-TS	1.398 (35.50)	1.234 (31.34)	1.500 (38.10)	M28X1-6g0.100R	.760 (19.30)
21	G	1.500 (38.10)	1.3750-0.1P-0.3L-TS	1.524 (38.70)	1.234 (31.34)	1.625 (41.28)	M31X1-6g0.100R	.760 (19.30)
23	H	1.618 (41.40)	1.5000-0.1P-0.3L-TS	1.642 (41.70)	1.234 (31.34)	1.750 (44.45)	M34X1-6g0.100R	.760 (19.30)
25	J	1.744 (44.30)	1.6250-0.1P-0.3L-TS	1.768 (44.90)	1.234 (31.34)	1.875 (47.62)	M37X1-6g0.100R	.760 (19.30)

Performance Specifications-Pages A-7, A-8.

Contacts, Sealing Plugs, Assembly Tools - Pages A-26, A-32, A-33.

Contact Arrangements - Pages A-24, A-25.

Dimensions shown in inches (mm)
Specifications and dimensions subject to change

www.ittcannon.com





A

Circular

Jam Nut Receptacle

D38999/24

KJA7T

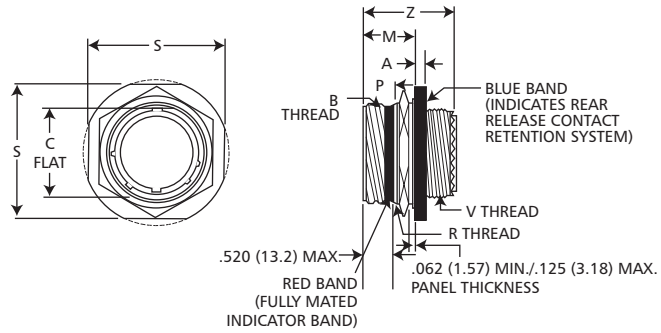

Shell Size	MS Shell Code	MS Shell size + .010 (.250) - .005 (.130)	A .104 (2.64)	B Thread Class 2A (Plated)	C +.004 (.100) -.010 (.250)	Z +.005 (.130) -.040 (.100)	M +.005 (.130) -.004 (.100)	P +.016 (.410) -.004 (.100)	S	Metric R Thread (Plated)	Metric V Thread (Plated)
9	A	.104 (2.64)	.104 (2.64)	.6250-0.1P-0.3L-TS	.651 (16.53)	1.243 (31.57)	.871 (22.12)	.555 (14.10)	1.062 (26.97)	M17X1-6g0.100R	M12X1-6g0.100R
11	B	.104 (2.64)	.104 (2.64)	.7500-0.1P-0.3L-TS	.751 (19.07)	1.243 (31.57)	.871 (22.12)	.555 (14.10)	1.250 (31.75)	M20X1-6g0.100R	M15X1-6g0.100R
13	C	.104 (2.64)	.104 (2.64)	.8750-0.1P-0.3L-TS	.938 (23.82)	1.243 (31.57)	.878 (22.30)	.563 (14.30)	1.375 (34.92)	M25X1-6g0.100R	M18X1-6g0.100R
15	D	.104 (2.64)	.104 (2.64)	1.0000-0.1P-0.3L-TS	1.062 (26.97)	1.243 (31.57)	.878 (22.30)	.563 (14.30)	1.500 (38.10)	M28X1-6g0.100R	M22X1-6g0.100R
17	E	.104 (2.64)	.104 (2.64)	1.1875-0.1P-0.3L-TS	1.187 (30.15)	1.243 (31.57)	.878 (22.30)	.563 (14.30)	1.625 (41.28)	M32X1-6g0.100R	M25X1-6g0.100R
19	F	.135 (3.43)	.135 (3.43)	1.2500-0.1P-0.3L-TS	1.312 (33.32)	1.243 (31.57)	.878 (22.30)	.563 (14.30)	1.812 (46.02)	M35X1-6g0.100R	M28X1-6g0.100R
21	G	.135 (3.43)	.135 (3.43)	1.3750-0.1P-0.3L-TS	1.437 (36.50)	1.243 (31.57)	.878 (22.30)	.563 (14.30)	1.938 (49.23)	M38X1-6g0.100R	M31X1-6g0.100R
23	H	.135 (3.43)	.135 (3.43)	1.5000-0.1P-0.3L-TS	1.562 (39.67)	1.243 (31.57)	.878 (22.30)	.563 (14.30)	2.062 (52.37)	M41X1-6g0.100R	M34X1-6g0.100R
25	J	.135 (3.43)	.135 (3.43)	1.6250-0.1P-0.3L-TS	1.687 (42.85)	1.243 (31.57)	.878 (22.30)	.563 (14.30)	2.188 (55.38)	M44X1-6g0.100R	M37X1-6g0.100R

Performance Specifications-Pages A-7, A-8.

Contacts, Sealing Plugs, Assembly Tools - Pages A-26, A-32, A-33.

Contact Arrangements - Pages A-24, A-25.

Panel Cutouts

Wall Mounted Receptacle

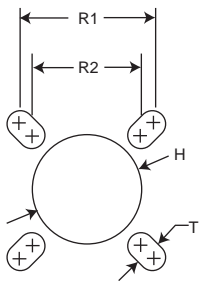

Jam Nut Receptacle

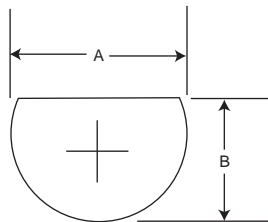

Shell Size	A +.010 (.25) -.000 (.00)	B +.000 (.00) -.010 (.25)	H +.010 (.25) -.000 (.00)	R1 (TP)	R2 (TP)	T (Max.)
9	.700 (17.78)	.670 (17.02)	.626 (15.90)	.719 (18.26)	.594 (15.09)	.134 (3.40)
11	.825 (20.96)	.771 (19.58)	.751 (19.08)	.812 (20.62)	.719 (18.26)	.134 (3.40)
13	1.010 (25.65)	.955 (24.26)	.876 (22.25)	.906 (23.01)	.812 (20.62)	.134 (3.40)
15	1.135 (28.83)	1.085 (27.56)	1.001 (25.43)	.969 (24.61)	.906 (23.01)	.134 (3.40)
17	1.260 (32.00)	1.210 (30.73)	1.188 (30.18)	1.062 (26.97)	.969 (24.61)	.134 (3.40)
19	1.385 (35.18)	1.335 (33.91)	1.251 (31.78)	1.156 (29.36)	1.062 (26.97)	.134 (3.40)
21	1.510 (38.35)	1.460 (37.08)	1.376 (34.95)	1.250 (31.75)	1.156 (29.36)	.134 (3.40)
23	1.635 (41.53)	1.585 (40.26)	1.511 (38.38)	1.375 (34.92)	1.250 (31.75)	.160 (4.06)
25	1.760 (44.70)	1.710 (43.43)	1.626 (41.30)	1.500 (38.10)	1.375 (34.92)	.160 (4.06)



Dimensions shown in inches (mm)
Specifications and dimensions subject to change

www.ittcannon.com



A

Circular

Polarizing Positions

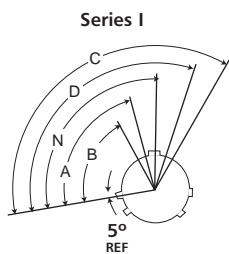

Series I
Front face of receptacle (plug opposite). Insert arrangement does not rotate with main key-keyway. The master key is rotated to provide shell polarization; the minor keys remain fixed.

Shell Size	Angle of Rotation (Degrees)				
	Normal	A	B	C	D
9	95°	77°			113°
11	95°	81°	67°	123°	109°
13	95°	75°	63°	127°	115°
15	95°	74°	61°	129°	116°
17	95°	77°	65°	125°	113°
19	95°	77°	65°	125°	113°
21	95°	77°	65°	125°	113°
23	95°	80°	69°	121°	110°
25	95°	80°	69°	121°	110°

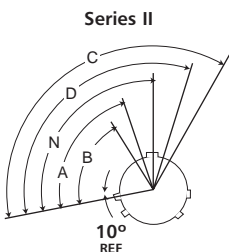

Series II
Front face of receptacle (plug opposite). Insert arrangement does not rotate with main key-keyway. The master key is rotated to provide shell polarization; the minor keys remain fixed.

Shell Size	Angle of Rotation (Degrees)				
	Normal	A	B	C	D
8	100°	82°			118°
10	100°	86°	72°	128°	114°
12	100°	80°	68°	132°	120°
14	100°	79°	66°	134°	121°
16	100°	82°	70°	130°	118°
18	100°	82°	70°	130°	118°
20	100°	82°	70°	130°	118°
22	100°	85°	74°	126°	115°
24	100°	85°	74°	126°	115°

Series III
RECEPTACLE
(Front face shown)

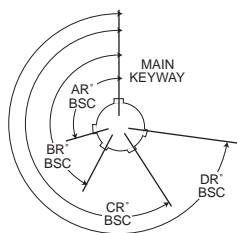

PLUG
(Front face shown)

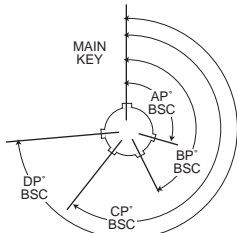

NOTES

1. All Angles are BSC
2. The insert arrangement does not rotate with main key/keyway
3. All minor keys are rotated to provide shell polarization, the master key remains fixed at twelve o'clock position.
4. Polarization is different from Series I and II.

Shell Size	Key & Keyway Arrangement Identification Letter	Key Locations			
		AR° or AP° or BSC	BR° or BP° or BSC	CR° or CP° or BSC	DR° or DP° or BSC
9	N	105	140	215	265
	A	102	132	248	320
	B	80	118	230	312
	C	35	140	205	275
	D	64	155	234	304
11	E	91	131	197	240
	N	95	141	208	236
13	A	113	156	182	292
	B	90	145	195	252
and 15	C	53	156	220	255
	D	119	146	176	298
17 and 19	E	51	141	184	242
	N	80	142	196	293
	A	135	170	200	310
	B	49	169	200	244
	C	66	140	200	257
21	D	62	145	180	280
	E	79	153	197	272
	N	80	142	196	293
23	A	135	170	200	310
	B	49	169	200	244
and 25	C	66	140	200	257
	D	62	145	180	280
25	E	79	153	197	272

Cannon KJL/KJ/KJA/KJB MIL-DTL-38999 Series I, II, III Connectors



Circular

A

Contact Arrangements (Engaging View Pin Insert)

* Socket insert only

** Pin insert only (Not available in socket insert Series I and III)

Indicates layouts are available in all shell styles including MS27499, MS27508, KJ2E and KJ5E
† Consult factory MS27505E/KJL5E insert availability

Series III	9-98	9-35	-	11-5	11-98	-	11-35	-	-	13-8
Series II	8-98†	8-35†	-	10-5†	10-98†	-	10-35†	12-3	12-4†	12-8†
Series I	9-98	9-35	11-4	11-5	11-98	11-99	11-35	-	13-4**	13-8
No. of Contacts	3 #20	6 #22D	4 #20	5 #20	6 #20	7 #20	13 #22D	3 #16	4 #16	8 #20
Service Ratings	I	M	I	I	I	I	M	II	I	I

Series III	13-98	13-35	15-5	15-15	15-18	15-19	15-35
Series II	12-98†	12-35†	14-5†	14-15†	14-18†	-	14-35†
Series I	13-98	13-35	15-5	15-15	15-18	15-19	15-35
No. of Contacts	10 #20	22 #22D	5 #16	14 #20, 1 #16	18 #20	19 #20	37 #22D
Service Ratings	I	M	II	I	I	I	M

Series III	15-97	17-6	17-8	17-26	17-35	-	16-99†
Series II	14-97†	16-6	16-8†	16-26†	16-35†	16-42†	17-99**
Series I	15-97	17-6	17-8	17-26	17-35	42 #22	17-99**
No. of Contacts	8 #20, 4 #16	6 #12	8 #16	26 #20	55 #22D	M	21 #20, 2 #16
Service Ratings	I	I	II	I	M	M	I

Series III	-	-	19-11	19-32	19-35
Series II	18-28	18-30	18-11	18-32†	18-35†
Series I	19-28**	19-30**	19-11	19-32	19-35
No. of Contacts	26 #20, 2 #16	29 #20, 1 #16	11 #16	32 #20	66 #22D
Service Ratings	I	I	II	I	M

Series III	21-11	21-16	21-35	21-39	21-41
Series II	-	20-16†	20-35†	20-39†	20-41†
Series I	21-11	21-16	21-35	21-39	21-41
No. of Contacts	11 #12	16 #16	79 #22D	37 #20, 2 #16	41 - #20
Service Ratings	I	II	M	I	I

Series III	21-75	23-21	-	23-35
Series II	-	22-21	22-32	22-35†
Series I	21-75*	23-21	23-32**	23-35
No. of Contacts	4 #8 Twinax	21 #16	32 #20	100 #22D
Service Ratings	M	II	I	M

Please consult factory for availability of layouts not shown.



Dimensions shown in inches (mm)
Specifications and dimensions subject to change

www.ittcannon.com



A

Circular

Contact Arrangements (Engaging View Pin Insert)

* Socket insert only

** Pin insert only (Not available in socket insert Series I and III)

† Indicates layouts are available in all shell styles including MS27499, MS27508, KJ2E and KJ5E

• Consult factory for MS27505E/KJL5E insert availability

Series III
Series II
Series I
No. of Contacts
Service Ratings

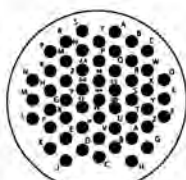

23-53
22-53†
23-53
53 #20
I

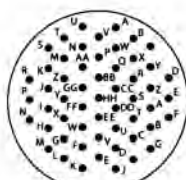

23-55
22-55†
23-55
55 #20
I

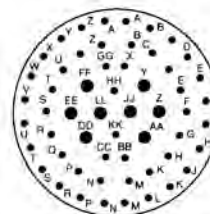

25-4
24-4†
25-4
48 #20, 8 #16
I

Series III
Series II
Series I
No. of Contacts
Service Ratings

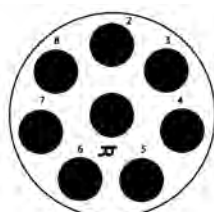

25-8
-
25-8*
8 #8 Twinax
Twinax

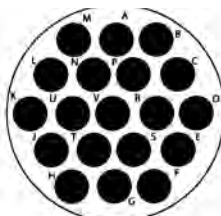

25-19
-
25-19
19 #12
I

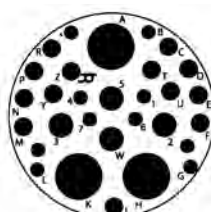

25-20
-
25-20*
3 #8 Twinax, 13 #16,
4 #12 Coax, 10 #20
N / Coax / Twinax

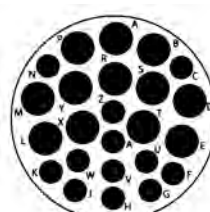

25-24
24-24†
25-24
12 #16, 12 #12
I

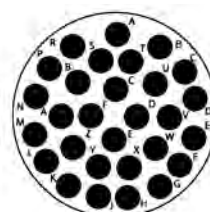

25-29
24-29†
25-29
29 #16
I

Series III
Series II
Series I
No. of Contacts
Service Ratings

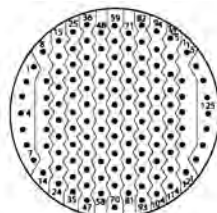

25-35
24-35†
25-35
128 #22D
M

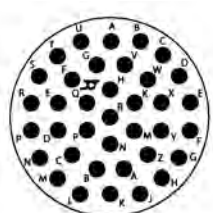

25-37
-
25-37*
37 #16
II

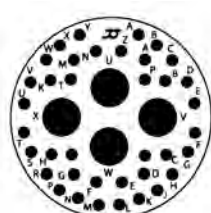

25-42
-
25-42*
38 #20, 4 #8 Coax
I, Coax

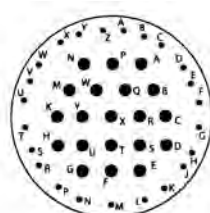

25-43
-
25-43
23 #20, 20 #16
I

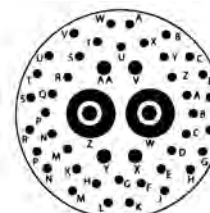

25-46
-
25-46
40 #20, 4 #16, 2 #8
Twinax

Series III
Series II
Series I
No. of Contacts
Service Rating

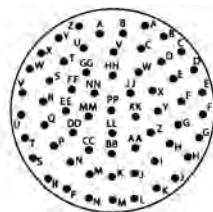

25-61
24-61†
25-61
61 #20
I

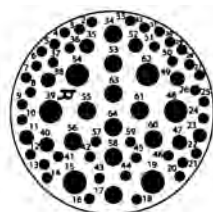

25-64
-
25-64
40 #22D, 8 #20
10 #16, 6 #12
I

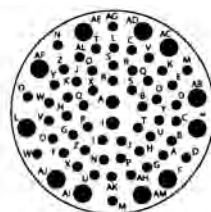

25-66*
-
25-66*
53 #22D, 2 #20, 11 #16
I

Cannon KJL/KJ/KJA/KJB MIL-DTL-38999 Series I, II, III Connectors



A

Circular

Contacts-Pin (Series I/II/III)

MIL-C-39029/58

KJL/KJ/KJA

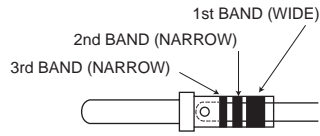

Contact Size	1	Color Bands 2	3	Cannon Part Number	M39029 Military Part Number
22D	Orange	Blue	Black	980-0008-878	M39029/58-360
20	Orange	Blue	Orange	980-0008-879	M39029/58-363
16	Orange	Blue	Yellow	980-0008-880	M39029/58-364
12	Orange	Blue	Green	980-0008-881	M39029/58-365

Contact Size		Cannon Part Number	Cable Accommodations
8 Coax	95 Ohms	249-2196-000	RG-180
		249-2196-001	RG-174, 179, 316
		249-2196-002	RG-142
8 Twinax	75 Ohms	980-1000-012	M17/176-00002
		12 Coax	980-1000-016

Contacts-Socket (Series II)

MIL-C-39029/57

KJ

Manufacture identification Code Area - Typical all contacts

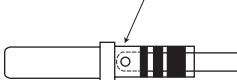

Contact Size	1	Color Bands 2	3	Cannon Part Number	M39029 Military Part Number
22D	Orange	Green	Yellow	980-0008-874	M39029/57-354
20	Orange	Green	Violet	980-0008-875	M39029/57-357
16	Orange	Green	Gray	980-0008-876	M39029/57-358
12	Orange	Green	White	980-0008-877	M39029/57-359

Contacts-Socket (Series I & III)

MIL-C-39029/56

KJL/KJA



Contact Size	1	Color Bands 2	3	Cannon Part Number	M39029 Military Part Number
22D	Orange	Yellow	Gray	980-0008-870	M39029/56-348
20	Orange	Green	Brown	980-0008-871	M39029/56-351
16	Orange	Green	Red	980-0008-872	M39029/56-352
12	Orange	Green	Orange	980-0008-873	M39029/56-353

Contact Size		Cannon Part Number	Cable Accommodations
8 Coax	95 Ohms	249-2195-000	RG-180
		249-2195-001	RG-174, 179, 316
		249-2195-002	RG-142
8 Twinax	75 Ohms	980-1000-013	M17/176-00002
		12 Coax	980-1000-015



Dimensions shown in inches (mm)
Specifications and dimensions subject to change

www.ittcannon.com



A

Circular

Contact Sealing Bushings

Size 8 Twinax Sealing Bushing 321-1035-000
Used with the Twinax contact in Twinax layouts for sealing cable size M17/176-00002

Size 8 Coax Sealing Bushing 321-1034-001
Used with the Coax contact in Twinax layouts for sealing cable size RG-180



Twinax Grommet



Coax Grommet

Contact Sealing Bushing Sequence into Twinax Grommet

(Bushing only used with Twinax grommet)

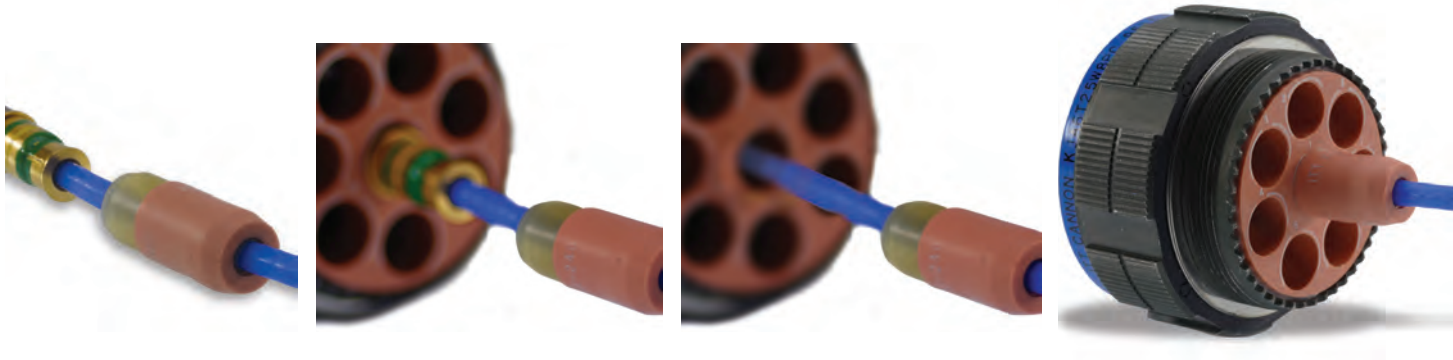

Dimensions shown in inches (mm)
Specifications and dimensions subject to change



Contacts-Printed Circuit Board

PIN PRINTED CIRCUIT CONTACT EXTENSION FROM REAR OF CONNECTOR (MAX / MIN)

PC CONTACT PART NUMBER	CONTACT SIZE	TAIL DIA. ±.001	MS27466 MS27467 KJL0 / KJL6	MS27656 MS27468 KJL3 / KJL7	MS27505E KJL5E	MS27472 MS27474 KJ0 / KJ7	MS27499E MS27508E KJ2E / KJ5E	MS27513E MS27497 / NO MS KJ2R / KJ3 / KJ5R	MS27473 MS27484 KJ6 / KJG6	D38999/20 KJA0	D38999/26 KJA6	D38999/24 KJA7 (9-17)	D38999/24 KJA7 (19-25)
030-2097-002	22D	0.020	0.261 0.189	0.244 0.176	0.408 0.376	0.264 0.226	0.408 0.376	0.264 0.226	0.264 0.226	0.262 0.200	0.266 0.194	0.280 0.216	0.258 0.198
030-2097-006	22D	0.020	0.069 N/A	0.052 N/A	0.216 0.184	0.072 0.034	0.216 0.184	0.072 0.034	0.072 0.034	0.070 0.008	0.074 0.002	0.088 0.024	0.066 0.006
030-2097-008	22D	0.020	0.216 0.144	0.199 0.131	0.363 0.331	0.219 0.181	0.363 0.331	0.219 0.181	0.219 0.181	0.217 0.155	0.221 0.149	0.235 0.171	0.213 0.153
030-2097-015	22D	0.020	0.293 0.221	0.276 0.208	0.440 0.408	0.296 0.258	0.440 0.408	0.296 0.258	0.296 0.258	0.294 0.232	0.298 0.226	0.312 0.248	0.290 0.230
030-1997-006	20	0.025	0.166 0.094	0.149 0.081	0.313 0.281	0.169 0.131	0.313 0.281	0.169 0.131	0.169 0.131	0.167 0.105	0.171 0.099	0.185 0.121	0.163 0.103
030-1997-022	20	0.025	0.281 0.209	0.264 0.196	0.428* 0.396*	0.284 0.246	0.428* 0.396*	0.284 0.246	0.284 0.246	0.282 0.220	0.286 0.214	0.300 0.236	0.278 0.218
030-1997-030	20	0.019	0.364 0.292	0.347 0.279	0.511 0.479	0.367 0.329	0.511 0.479	0.367 0.329	0.367 0.329	0.365 0.303	0.369 0.297	0.383 0.319	0.361 0.301
030-1995-023	16	0.062	0.278 0.206	0.261 0.193	0.425 0.393	0.281 0.243	0.425 0.393	0.281 0.243	0.281 0.243	0.279 0.217	0.283 0.211	0.297 0.233	0.275 0.215
030-1995-024	16	0.062	0.118 0.046	0.101 0.033	0.265 0.233	0.121 0.083	0.265 0.233	0.121 0.083	0.121 0.083	0.119 0.057	0.123 0.051	0.137 0.073	0.115 0.055

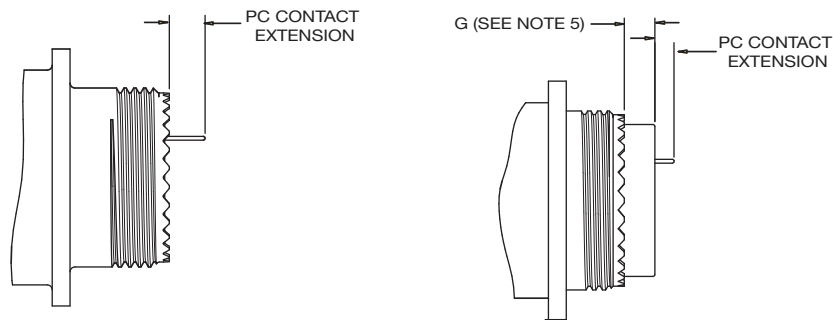

(KJL0/3/6/7 & KJA0/6/7)

(KJL5E, KJ0/2E/2R/3/5E/5R/6/7, & KJG6)

SOCKET (SERIES II) PRINTED CIRCUIT CONTACT EXTENSION FROM REAR OF CONNECTOR (MAX / MIN)

PC CONTACT PART NUMBER	CONTACT SIZE	TAIL DIA. ±.001	MS27472 MS27474 KJ0 / KJ7	MS27499E MS27508E KJ2E / KJ5E	MS27513E MS27497 / NO MS KJ2R / KJ3 / KJ5R	MS27473 MS27484 KJ6 / KJG6
031-1186-006	22D	0.020	0.179 0.141	0.323 0.291	0.179 0.141	0.179 0.141
031-1186-011	22D	0.020	0.109 0.071	0.253 0.221	0.109 0.071	0.109 0.071
031-1186-013	22D	0.020	0.217 0.179	0.361 0.329	0.217 0.179	0.217 0.179
031-1186-021	22D	0.020	0.262 0.224	0.406 0.374	0.262 0.224	0.262 0.224
031-1124-021	20	0.025	0.247 0.209	0.391* 0.359*	0.247 0.209	0.247 0.209
031-1123-007	16	0.062	0.101 0.063	0.245 0.213	0.101 0.063	0.101 0.063

SOCKET (SERIE I & III) PRINTED CIRCUIT CONTACT EXTENSION FROM REAR OF CONNECTOR (MAX / MIN)

PC CONTACT PART NUMBER	CONTACT SIZE	TAIL DIA. ±.001	MS27466 MS27467 KJL0 / KJL6	MS27656 MS27468 KJL3 / KJL7	MS27505E KJL5E	D38999/20 KJA0	D38999/26 KJA6	D38999/24 KJA7 (9-17)	D38999/24 KJA7 (19-25)
031-1147-014	22D	0.021	0.244 0.172	0.227 0.159	0.391* 0.359*	0.245 0.183	0.249 0.177	0.263 0.199	0.241 0.181
031-1147-039	22D	0.020	0.168 0.096	0.151 0.083	0.315* 0.283*	0.169 0.107	0.173 0.101	0.187 0.123	0.165 0.105
031-1147-040	22D	0.020	0.438 0.366	0.421 0.353	0.585* 0.553*	0.439 0.377	0.443 0.371	0.457 0.393	0.435 0.375
031-1124-040	20	0.025	0.486 0.414	0.469 0.401	0.633 0.601	0.487 0.425	0.491 0.419	0.505 0.441	0.483 0.423
031-1123-020	16	0.029	0.272 0.200	0.255 0.187	0.419 0.387	0.273 0.211	0.277 0.205	0.291 0.227	0.269 0.209

NOTES: UNLESS OTHERWISE SPECIFIED.

1. PC CONTACTS HAVE GOLD PLATING OVER SUITABLE UNDERPLATE PER MIL-C-39029 SPECIFICATION.
2. PC CONTACT EXTENSIONS APPLY TO ITT CANNON CONNECTORS ONLY FOR ALL SHELL SIZES.
3. N/A INDICATES NO EXTENSION.
4. * INDICATES PC TAIL WITH STEP EXTENDING FROM REAR OF CONNECTOR.
5. G DIM. IS .031 +/- .016 FOR KJL5E AND .120 +/- .030 (SHELL SIZES 8 THRU 22) AND .090 +/- .050 (SHELL SIZE 24) FOR KJ0/2E/2R/3/5E/5R/6/7 & KJG6.
6. FOR OTHER SPECIFIC PC CONTACT DATA, CONSULT ITT EC, SANTA ANA, CA, USA.



Dimensions shown in inches (mm)
Specifications and dimensions subject to change

www.ittcannon.com



A

Circular

Wire Sizes and Diameters

Contact Size	Wire size (AWG)	Finished wire outside dimensions	
		Minimum	Maximum
22D	28, 26, 24, 22	0.030	0.054
22M*	28, 26, 24	0.030	0.050
22*	26, 24, 22	0.034	0.060
20	24, 22, 20	0.040	0.083
16	20, 18, 16	0.065	0.109
12	14, 12	0.097	0.142
8 Coax	RG-180	0.136	0.146
8 Twinax	M17/176-00002	0.124	0.134
12 Coax	RG174, 179, 316	0.094	0.102

*For reference only

Recommended Jam Nut Torque Values

Series II		Series I & III	
Shell Size	Inch-Pounds	Shell Size	Inch-Pounds
8	46/50	9	30/36
10	55/60	11	40/46
12	70/75	13	55/60
14	80/85	15	70/75
16	90/95	17	80/85
18	100/110	19	90/95
20	110/120	21	100/110
22	120/130	23	110/120
24	140/150	25	120/130

Coupling Nut Torque Values (Series I, II and III)

Maximum engagement and disengagement		Minimum disengagement
Shell Size	Inch Pound	Inch Pound
8	8	2
9	8	2
10	12	2
11	12	2
12	16	2
13	16	2
14	20	4
15	20	3
16	24	4
17	24	3
18	28	5
19	28	3
20	32	6
21	32	5
22	36	7
23	36	5
24	36	7
25	40	5



A

Circular

Backshell - Type E (Straight), Series II only

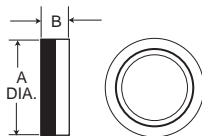

Shell Size		
Series II	A Dia. Max.	B Dia. Max.
8	.580 (14.73)	.328 (8.33)
10	.705 (17.91)	.328 (8.33)
12	.830 (21.08)	.328 (8.33)
14	.955 (24.26)	.328 (8.33)
16	1.080 (27.32)	.328 (8.33)
18	1.205 (30.61)	.328 (8.33)
20	.330 (33.78)	.328 (8.33)
22	1.455 (36.96)	.328 (8.33)
24	1.555 (39.50)	.270 (6.86)

How To Order

Shell Size	Finishes			
	A	B	C	N
Series II	Cadmium/Nickel-Clear Part Number	Cadmium/Nickel-O.D Part Number	Anodic Non-Cond. Part Number	Electroless Nickel Part Number
8	057-0776-000	057-0862-000	057-0819-000	057-0776-002
10	057-0777-000	057-0863-000	057-0820-000	057-0777-002
12	057-0778-000	057-0864-000	057-0821-000	057-0778-002
14	057-0779-000	057-0846-000	057-0822-000	057-0779-002
16	057-0780-000	057-0847-000	057-0823-000	057-0780-002
18	057-0781-000	057-0848-000	057-0824-000	057-0781-002
20	057-0782-000	057-0849-000	057-0825-000	057-0782-002
22	057-0783-000	057-0850-000	057-0826-000	057-0783-002
24	057-0784-000	057-0851-000	057-0827-000	057-0784-002

Backshell - Type F (Cable Clamp)

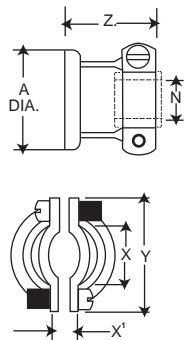

Shell Size							
Series I	Series II	A Max.	N Dia. Max.	X Dia. Min.	X' Dia. Min.	Y Max.	Z Max.
9	8	.508 (14.73)	.135 (3.43)	.234 (5.94)	.187 (4.75)	.829 (21.06)	.813 (20.65)
11	10	.705 (17.91)	.198 (5.03)	.297 (7.54)	.187 (4.75)	.891 (22.63)	.813 (20.65)
13	12	.830 (21.08)	.322 (7.18)	.422 (10.72)	.281 (7.14)	1.016 (25.81)	.813 (20.65)
15	14	.955 (24.26)	.385 (9.78)	.547 (12.89)	.325 (8.26)	1.141 (28.98)	.813 (20.65)
17	16	1.080 (27.43)	.510 (12.95)	.609 (15.47)	.356 (9.04)	1.203 (30.56)	.933 (23.70)
19	18	1.205 (30.61)	.635 (16.13)	.734 (18.64)	.456 (11.58)	1.469 (37.31)	.933 (23.70)
21	20	1.330 (33.78)	.635 (16.13)	.734 (18.64)	.519 (13.18)	1.469 (37.31)	.933 (23.70)
23	22	1.455 (36.96)	.760 (19.30)	.922 (23.42)	.519 (13.18)	1.656 (42.06)	.933 (23.70)
25	24	1.555 (39.50)	.810 (20.57)	.984 (24.99)	.657 (16.69)	1.750 (44.45)	.893 (22.68)

How To Order (MS Version)

MS27506 - A - 8 - 2

Military Designation
MS27506 Type F Straight with Cable Clamp

Finish
A - Cad/Nickel (Clear)
B - Cad/Nickel (O.D)
F - Nickel (Electroless)

Shell Size
Series I - 9, 11, 13, 15, 17, 19, 21, 23, 25
Series II - 8, 10, 12, 14, 16, 18, 20, 22, 24

Adapter
Geometry - 2

Shell Size		Finishes							
Series I	Series II	MS Part Number	Cannon Part Number	A Cannon	A MS	B Cannon	B MS	N Cannon	F MS
9	8	27506*-8-2	057-3005-***	-012	A	-013	B	-015	F
11	10	27506*-10-2	057-3006-***	-011	A	-012	B	-014	F
13	12	27506*-12-2	057-3007-***	-012	A	-013	B	-015	F
15	14	27506*-14-2	057-3008-***	-010	A	-011	B	-013	F
17	16	27506*-16-2	057-3009-***	-012	A	-013	B	-015	F
19	18	27506*-18-2	057-3010-***	-013	A	-014	B	-016	F
21	20	27506*-20-2	057-3011-***	-011	A	-013	B	-015	F
23	22	27506*-22-2	057-3012-***	-015	A	-016	B	-018	F
25	24	27506*-24-2	057-3013-***	-013	A	-014	B	-017	F

* MS Finish *** Cannon Finish





A

Circular

Shell Size Series III	Military Part Number	Cannon Part Number	Cannon	Military	Cannon	Military
9	M85049/ 38-9 **	970-6000-***	-336	N	-345	W
11	M85049/ 38-11 **	970-6000-***	-337	N	-346	W
13	M85049/ 38-13 **	970-6000-***	-338	N	-347	W
15	M85049/ 38-15 **	970-6000-***	-339	N	-348	W
17	M85049/ 38-17 **	970-6000-***	-340	N	-349	W
19	M85049/ 38-19 **	970-6000-***	-341	N	-350	W
21	M85049/ 38-21 **	970-6000-***	-342	N	-351	W
23	M85049/ 38-23 **	970-6000-***	-343	N	-352	W
25	M85049/ 38-25 **	970-6000-***	-344	N	-353	W

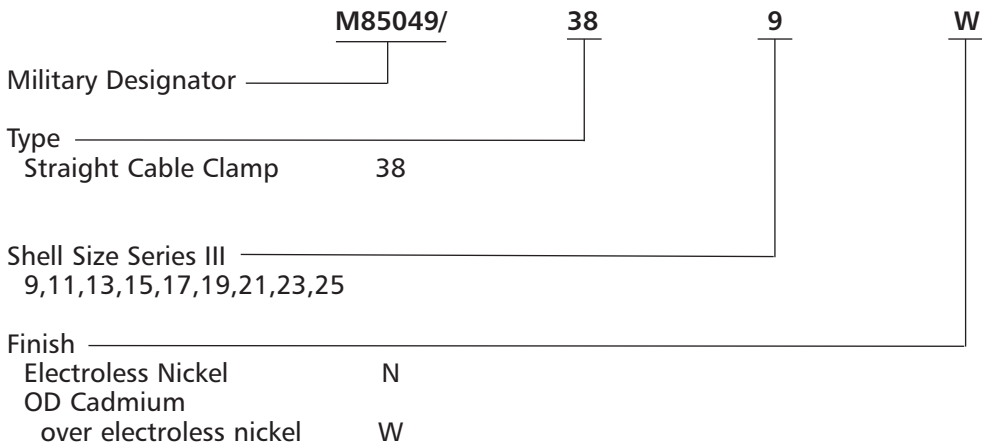

** Finish

*** Cannon Part No.



Cannon KJL/KJ/KJA/KJB MIL-DTL-38999 Series I, II, III Connectors



A

Circular

Backshell - Type P (Potting Boot)

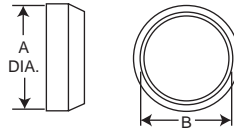

Shell Size		A Dia. Max.	B Dia. Max.
Series I	Series II		
9	8	.598 (15.19)	.434 (11.02)
11	10	.723 (18.36)	.548 (13.92)
13	12	.847 (21.51)	.673 (17.09)
15	14	.969 (24.61)	.798 (20.27)
17	16	1.087 (27.61)	.899 (22.83)
19	18	1.211 (30.76)	1.024 (26.01)
21	20	1.336 (33.93)	1.141 (29.98)
23	22	1.461 (37.11)	1.274 (32.36)
25	24	1.586 (40.28)	1.399 (35.53)

How To Order (MS Version)

MS Designation _____

Shell Size _____

Series I - 9, 11, 13, 15, 17, 19, 21, 23, 25

Series II - 8, 10, 12, 14, 16, 18, 20, 22, 24

1 - Straight Cup

MS27486 - 10 - 1

NOTE: When ordering the MS version you must specify both MS numbers for the Potting Boot and the Adapter Ring.

Shell Size		MS27486 Part Number	Cannon Part Number
Series I	Series II		
9	8	27486**-1	040-0185-000
11	10	27486**-1	040-0169-000
13	12	27486**-1	040-0170-000
15	14	27486**-1	040-0171-000
17	16	27486**-1	040-0172-000
19	18	27486**-1	040-0173-000
21	20	27486**-1	040-0174-000
23	22	27486**-1	040-0175-000
25	24	27486**-1	040-0176-000

** Only even numbered shell size is applicable.

Potting Boot Adapter Ring

How To Order (MS Version)

Military Designation _____

Finish _____

A - Cad/Nickel (Clear)

B - Cad/Nickel (O.D)

F - Nickel (Electroless)

Shell Size _____

Series I - 9, 11, 13, 15, 17, 19, 21, 23, 25

Series II - 8, 10, 12, 14, 16, 18, 20, 22, 24

MS27485 - A - 8

NOTE: When ordering the MS version you must specify both MS numbers for the Potting Boot and the Adapter Ring.

Shell Size		MS27485 Part Number	Cannon Part Number	Finishes					
Series I	Series II			A		B	N	F	
				Cadmium/Nickel	Clear	Cadmium/Nickel-O.D	Electroless	Nickel	
9	8	27485*-***	237-0887-***	-000	A	-001	B	-002	F
11	10	27485*-***	237-0874-***	-000	A	-001	B	-002	F
13	12	27485*-***	237-0875-***	-000	A	-001	B	-002	F
15	14	27485*-***	237-0876-***	-000	A	-001	B	-002	F
17	16	27485*-***	237-0877-***	-000	A	-001	B	-002	F
19	18	27485*-***	237-0878-***	-000	A	-001	B	-002	F
21	20	27485*-***	237-0879-***	-000	A	-001	B	-002	F
23	22	27485*-***	237-0880-***	-000	A	-001	B	-003	F
25	24	27485*-***	237-0881-***	-000	A	-001	B	-003	F

* MS Finish

** Only even numbered shell size is applicable

*** Cannon Finish

Wire Sealing Plugs

Series III Size	Series I & II Size	Part Number		Color Code
		Cannon	MS27488	
22D	22D	225-1013-000	MS27488-22-2	Black
20	20	225-0070-000	MS27488-20-2	Red
16	16	225-0104-000	MS27488-16-2	Green
12	12	225-0105-000	MS27488-12-2	Orange

Wire sealing plugs meet MS27488 standards. The plugs are color coded according to size for easy identification. Wire sealing plugs may be ordered separately.



Dimensions shown in inches (mm)
Specifications and dimensions subject to change

www.ittcannon.com



A

Circular

Tools - Crimp



M22520/1-01

CBT-530



M22520/2-01



CBT-565

Contact Size	Pin Contact Series I/II/III		Socket Contact Series II		Socket Contact Series I & III	
	Crimp Tool Part Number	Locator or Turret Part Number	Crimp Tool Part Number	Locator or Turret Part Number	Crimp Tool Part Number	Locator or Turret Part Number
22D or 22M*	M22520/2-01	M22520/2-09	M22520/2-01	M22520/2-06	M22520/2-01	M22520/2-07
22*	M22520/2-01	M22520/2-09	M22520/2-01	M22520/2-06	M22520/2-01	M22520/2-07
20	M22520/1-01	M22520/1-04 OR TH 187	M22520/1-01	M22520/1-04	M22520/1-01	M22520/1-04
16	M22520/1-01	M22520/1-04 OR TH 187	M22520/1-01	M22520/1-04	M22520/1-01	M22520/1-04
12	M22520/1-01	M22520/1-04	M22520/1-01	M22520/1-04	M22520/1-01	M22520/1-04
8 Coax Inner Conductor	Crimp Tool	Crimp Tool Locator	Outer Conductor		Crimp Tool	Crimp Tool Locator
RG180	M22520/2-01	995-0002-268	RG180		M22520/5-01	M22520/5-39B
RG 174, 179, 316	M22520/2-01	995-0002-268	RG 174, 179, 316		M22520/5-01	M22520/5-37B
RG 142	M22520/2-01	995-0002-268	RG 142		M22520/5-01	M22520/5-19B
12 Coax Inner Conductor	Crimp Tool	Crimp Tool Locator	Outer Conductor		Crimp Tool	Crimp Tool Locator
RG174, 179, 316	M22520/2-01	M22520/2-34	RG174, 179, 316		M22520/31-01	M22520/31-02
8 Twinax Center Contact	Crimp Tool	Crimp Tool Locator				
	M22520/2-01	K709				
Intermediate Contact	M22520/5-01	Y631 Die Closure B				
Outer Contact	M22520/5-01	Y631 Die Closure A				

* For reference only

Tools - Plastic



Insertion/Extraction

Contact Size	Cannon Description	Cannon Part Number	M81969 Part Number	Superseded Military Part Number	Insertion Color Tip	Extraction Color Tip
22D	CIET-22D-01	274-7048-000	M81969/14-01	MS27534-22D	Green	White
22M*	CIET-22D-01	274-7048-000	M81969/14-01	MS27534-22D	Green	White
20	CIET-20-10	274-7001-000	M81969/14-10	MS27534-20	Red	Orange
16	CIET-16-03	274-7002-000	M81969/14-03	MS27534-16	Blue	White
12	CIET-12-04	274-7003-000	M81969/14-04	MS27534-12	Yellow	White
8 Coax/Twinax	CET8-T	323-7004-001	—	—	—	—
12 Coax	CIET-12-04	274-7003-000	M81969/14-04	M527534-12	Yellow	White

Insertion tool not required for size 8

Tools - Metal (MS)



Insertion



Extraction

Contact Size	Insertion			Extraction			
	MS27495 Part Number	ITT CANNON Part Number	Color Band	MS27495 Part Number	ITT CANNON Part Number	Color Band	
						No.1	No.2
22D OR 22M*	MS27495 A22M	995-0001-718	Black	MS27495 R22M	995-0001-719	Black	White
22*	MS27495 A22	995-0001-720	Brown	MS27495 R22	995-0001-721	Brown	White
20	MS27495 A20	995-0001-716	Red	MS27495 R20	995-0001-717	Red	White
16	MS27495 A16	995-0001-732	Blue	MS27495 R16	995-0001-731	Blue	White

Band No. 1 indicates tool size.
Band No. 2 indicates removal tool.

* For reference only

Dimensions shown in inches (mm)
Specifications and dimensions subject to change

Assembly Instructions

Circular

A

Wire Stripping

Strip insulation from end of wire to be crimped. (See table for proper stripping dimensions.) Do not cut or damage wire strands.

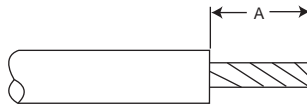

Wire Size	A
22D or 22M*	.125 (3.18)
20	.188 (4.77)
16	.188 (4.77)
12	.188 (4.77)

* For reference only

Contact Crimping

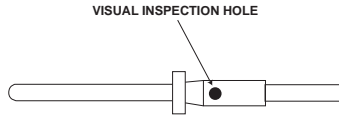

1. Insert stripped wire into contact crimp pot. Wire must be visible thru inspection hole.

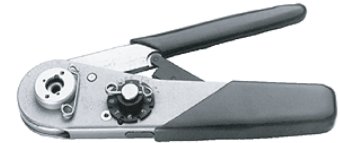

2. Using correct crimp tool and locator, cycle the tool once to be sure the indentors are open. Insert contact and wire into locator. Squeeze tool handles firmly and completely to insure a proper crimp. The tool will not release unless the crimp indentors in the tool head have been fully actuated.



3. Release crimped contact and wire from tool. Be certain the wire is visible thru inspection hole in contact.

Contact Insertion



1. Remove hardware from plug or receptacle and slip over wire bundle in proper order for reassembly.



2. Using proper plastic or metal insertion tool for corresponding contact, position wire in tip of the tool so that the tool tip butts up against the contact shoulder.



3. Press tool against contact shoulder and, with firm and even pressure, insert wired contact and tool tip into center contact cavity. A slight click may be heard as metal retaining tines snap into place behind contact shoulder.



4. Remove tool and pull back lightly on wire to make sure contact is properly seated. Repeat operation with remainder of contacts to be inserted, beginning with the center cavity and working outward in alternating rows.



5. After all contacts are inserted, fill any empty cavities with wire sealing plugs, Reassemble plug or receptacle hardware.

Contact Extraction

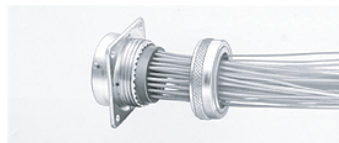

1. Remove hardware from plug or receptacle and slide hardware back along wire bundle.



2. Using plastic or metal extraction tool with proper color code corresponding to contact size, place wire in tool.



3. Insert tool into contact cavity until tool tip bottoms against the contact shoulder, expanding clip retaining tines.



4. Hold wire firmly in tool and extract wired contact and tool. Repeat operation for all contacts to be extracted.



5. Fill any empty wire cavities with wire sealing plugs, and



6. Reassemble plug or receptacle.



A

Circular

MIL-DTL-38999 Specifications

The following excerpts are some of the parameter requirements of the MIL-DTL-3899 Specification.

Test Description	Paragraph Reference	Requirements																																																																						
Contact Retention	4 5 19	After preloading to 3 pounds maximum, the force shall be applied at a rate of approximately 1 pound per second and maintained at full load for 5-10 seconds. No damage to contacts or insert shall result nor shall the contacts be dislocated from their normal position in the connector more than 0.012 inch under the given load. Failure to meet these requirements shall be cause for rejection.																																																																						
		<table border="1"> <thead> <tr> <th>Contact Size</th> <th>22M*</th> <th>22D</th> <th>22*</th> <th>20</th> <th>18</th> </tr> </thead> <tbody> <tr> <td>Loads in Pounds ± 10%</td> <td>10</td> <td>10</td> <td>10</td> <td>15</td> <td>25</td> </tr> </tbody> </table>	Contact Size	22M*	22D	22*	20	18	Loads in Pounds ± 10%	10	10	10	15	25																																																										
Contact Size	22M*	22D	22*	20	18																																																																			
Loads in Pounds ± 10%	10	10	10	15	25																																																																			
Coupling Torque	4 5 6	For qualification testing, mating halves shall be coupled and uncoupled, measuring the torques necessary. The torques required to couple and uncouple mating connector halves shall fall within the limits specifications as follows:																																																																						
		<table border="1"> <thead> <tr> <th colspan="3">Torque</th> <th colspan="3">Torque</th> <th colspan="3">Torque</th> <th colspan="3">Torque</th> </tr> <tr> <th>Shell Size</th> <th>Max.</th> <th>Min.</th> <th>Shell Size</th> <th>Max.</th> <th>Min.</th> <th>Shell Size</th> <th>Max.</th> <th>Min.</th> <th>Shell Size</th> <th>Max.</th> <th>Min.</th> </tr> </thead> <tbody> <tr> <td>8/9</td> <td>8</td> <td>2</td> <td>14</td> <td>20</td> <td>4</td> <td>18</td> <td>28</td> <td>5</td> <td>22</td> <td>36</td> <td>7</td> </tr> <tr> <td>10/11</td> <td>12</td> <td>2</td> <td>15</td> <td>20</td> <td>3</td> <td>19</td> <td>28</td> <td>3</td> <td>23</td> <td>36</td> <td>5</td> </tr> <tr> <td>12</td> <td>16</td> <td>2</td> <td>16</td> <td>24</td> <td>4</td> <td>20</td> <td>32</td> <td>6</td> <td>24</td> <td>36</td> <td>7</td> </tr> <tr> <td>13</td> <td>16</td> <td>2</td> <td>17</td> <td>24</td> <td>3</td> <td>21</td> <td>32</td> <td>5</td> <td>25</td> <td>40</td> <td>5</td> </tr> </tbody> </table>	Torque			Torque			Torque			Torque			Shell Size	Max.	Min.	Shell Size	Max.	Min.	Shell Size	Max.	Min.	Shell Size	Max.	Min.	8/9	8	2	14	20	4	18	28	5	22	36	7	10/11	12	2	15	20	3	19	28	3	23	36	5	12	16	2	16	24	4	20	32	6	24	36	7	13	16	2	17	24	3	21	32	5	25
Torque			Torque			Torque			Torque																																																															
Shell Size	Max.	Min.	Shell Size	Max.	Min.	Shell Size	Max.	Min.	Shell Size	Max.	Min.																																																													
8/9	8	2	14	20	4	18	28	5	22	36	7																																																													
10/11	12	2	15	20	3	19	28	3	23	36	5																																																													
12	16	2	16	24	4	20	32	6	24	36	7																																																													
13	16	2	17	24	3	21	32	5	25	40	5																																																													
Durability	4 5 7	Connector halves shall be mated and unmated 250 times for Series II with ground fingers and 500 times for Series I and III at a rate not exceeding 300 cycles per hour. The test may be performed by hand or by mechanical means, but the coupling ring shall be operated as in normal service. Failure to complete this test because of mechanical malfunction shall be cause for rejection.																																																																						
Insulation Resistance	4 5 9	An insulation resistance test shall be performed on unmated connectors in accordance with MIL-STD-202, Method 302, Test condition B. Measurement shall be made between three pairs of adjacent contacts and the shell. Failure to meet the minimum requirement of 50,000 megohms for Classes E, P, F, R, and T shall be cause for rejection.																																																																						
Vibration	4 5 22	Wired, mated connectors shall be subjected to the vibration test of MIL-STD-202, Method 214, Test Condition II, except that the duration shall be one hour in each plane. Receptacles shall be mounted on the vibration fixture by normal means. All contacts shall be wired in a series circuit and 100-500 milliamperes of current shall be allowed to flow through the series circuit during vibration. Suitable means shall be employed to monitor the current flow and to indicate any discontinuity of more than 1 microsecond. The wire bundle shall be damped to the nonvibrating points at least 8 inches from the rear of the connector. Current discontinuity of 1 microsecond or more, disengagement of the mated connectors, evidence of cracking, breaking, or loosening of parts shall be cause for rejection.																																																																						
Shock	4 5 23	Wired mated connectors shall be subjected to one shock in each direction in each of three mutually perpendicular axes. The pulse shall be approximate half sine wave of 300g ± 15% magnitude with a duration of 3 ± 1 milliseconds. Receptacles shall be mounted on a shock fixture by normal means. All contacts shall be wired in a series circuit and 100-150 ma. of current shall flow through the series circuit during shock. Suitable means shall be employed to monitor the current flow and to indicate any discontinuity of more than 1 microsecond. The wire bundle shall be clamped to fixed points at least 8 inches from the rear of the connector, Current discontinuity of 1 microsecond or more, disengagement of the mated connectors, evidence of cracking, breaking, or loosening of parts shall be cause for rejection.																																																																						
Thermal Shock	4 5 4	Unmated receptacles shall be subjected to 10 cycles of thermal shock in the following manner: Step a The receptacle shall be suspended for 10 + 1 - 0 minutes in the center of a cold water bath with a volume of approximately one cubic foot. No dimension of the bath shall be less than 10 inches. The water temperature shall not exceed 4°C (39.20°F) Step b The receptacle shall be suspended for 10 1 - 0 minutes in the center of a hot water bath with a volume of approximately one cubic foot. No dimension of the bath shall be less than 10 inches. The water temperature shall be not less than 94°C (201°F). The time of transfer from one bath to the other shall not exceed 5 seconds. At the end of the tenth cycle, the receptacle shall have the excess moisture shaken off and shall then be dried in a forced air oven at 66±5°C for 15 ± 1 minutes. Any evidence of damage resulting from this test shall be cause for rejection.																																																																						
Altitude Immersion	4 5 8	Mated connectors shall be placed in a container of water at approximately 20°C and placed in an altitude chamber. All wire ends shall be located within the chamber and exposed to the chamber atmosphere, but not submerged. The exposed wire ends shall not be sealed. A quantity of salt, 5 percent by weight, shall be added to make the water conductive. The chamber pressure shall then be reduced to approximately one inch of mercury and maintained for thirty minutes. The chamber pressure shall then be slowly returned to atmospheric. This shall be considered one cycle. Two additional cycles shall be performed. At the end of the last cycle, while the mated connectors are still submerged, the Insulation Resistance Test (room temperature), and the High Potential Test (sea level voltages) shall be performed upon the same circuits. Failure to meet an insulation resistance minimum of 2,000 megohms or any evidence of dielectric breakdown or -flashover shall be cause for rejection.																																																																						
Solvent Immersion	4 5 29	Unmated connectors shall be immersed fully in the applicable fluid specified below for 20 hours. After removal from the fluid, each connector shall remain for one hour in free air at room temperature. a.) Jet fuel JP-4 to MIL-J-5624 b.) Aircraft lubricating oil to MIL-L-9236																																																																						
Corrosion	4 5 12	Unmated connectors and individual contact samples shall be subjected to the soft spray of MIL-STD-202, Method 101, Test Condition 8 (tin plated, Class Y receptacles-24 hours). Immediately after exposure, the surfaces of the specimens shall be thoroughly washed in tap water and dried in a circulatory oven at a temperature of 38 ± 3°C (100°F) for a period of approximately 12 hours. Any exposure of basis metal as a result of this test, shall be cause for rejection.																																																																						
Dynamic Salt Spray	4 5 12 2	(Series I and 11, finish B; Series III, class W). The wired assembled plugs and receptacles shall be mated and unmated 50 cycles at a rate of 300 cycles per hour maximum. The mating and unmating shall be accomplished so that the plug and receptacle are completely separated during each cycle. The connectors shall then be subjected to the salt spray test in accordance with method 1001 of MIL-STD- 1344. The connectors shall be tested for 452 hours mated followed by 48 hours unmated. After the salt spray exposure the remaining number of durability cycles specified in 4.7.7 shall be completed.																																																																						
Temperature Durability	4 5 33	Wired rated connectors shall be subjected to the indicated ambient temperature for a period of 1,000 hours <table border="1"> <tbody> <tr> <td>Series I and II (finish A)</td> <td>150^{+3°}_{-0°C} (302° F)</td> <td>Series I and II (finish B)</td> <td>175^{+3°}_{-0°C} (347° F)</td> </tr> <tr> <td>Series III (class W)</td> <td>175^{+3°}_{-0°C} (347° F)</td> <td>All other finishes</td> <td>200^{+3°}_{-0°C} (392° F)</td> </tr> </tbody> </table>	Series I and II (finish A)	150 ^{+3°} _{-0°C} (302° F)	Series I and II (finish B)	175 ^{+3°} _{-0°C} (347° F)	Series III (class W)	175 ^{+3°} _{-0°C} (347° F)	All other finishes	200 ^{+3°} _{-0°C} (392° F)																																																														
Series I and II (finish A)	150 ^{+3°} _{-0°C} (302° F)	Series I and II (finish B)	175 ^{+3°} _{-0°C} (347° F)																																																																					
Series III (class W)	175 ^{+3°} _{-0°C} (347° F)	All other finishes	200 ^{+3°} _{-0°C} (392° F)																																																																					

* For reference only