

DATA SHEET

SURFACE-MOUNT CERAMIC MULTILAYER CAPACITORS

General purpose

Class 1, NP0

16 V TO 50 V

0.22 pF to 33 nF

RoHS compliant & Halogen Free

www.pdf.support

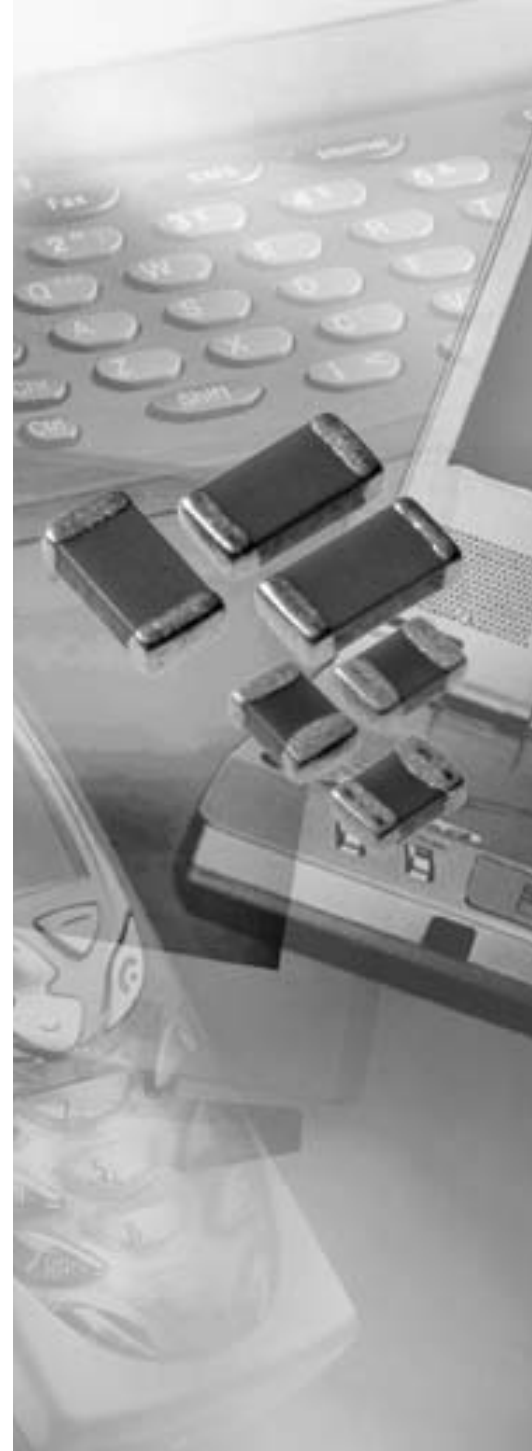

SCOPE

This specification describes NP0 series chip capacitors with lead-free terminations.

APPLICATIONS

- Consumer electronics for example
 - Tuners
 - Television receivers
 - All types of cameras
- Telecommunications
- Data processing

FEATURES

- Supplied in tape on reel
- Nickel-barrier end termination
- RoHS compliant
- Halogen Free compliant

ORDERING INFORMATION-GLOBAL PART NUMBER, PHYCOMP

CTC & I2NC

All part numbers are identified by the series, size, tolerance, TC material, packing style, voltage, process code, termination and capacitance value.

YAGEO BRAND ordering code

GLOBAL PART NUMBER (PREFERRED)

CC XXXX X X **NPO** X **BN** XXX
 (1) (2) (3) (4) (5)

(1) SIZE – INCH BASED (METRIC)

- 0201 (0603)
- 0402 (1005)
- 0603 (1608)
- 0805 (2012)
- 1206 (3216)
- 1210 (3225)
- 1812 (4532)

(2) TOLERANCE

- B = ±0.1 pF
- C = ±0.25 pF
- D = ±0.5 pF
- F = ±1%
- G = ±2%
- J = ±5%

(3) PACKING STYLE

- R = Paper/PE taping reel; Reel 7 inch
- K = Blister taping reel; Reel 7 inch
- P = Paper/PE taping reel; Reel 13 inch
- F = Blister taping reel; Reel 13 inch
- C = Bulk case

(4) RATED VOLTAGE

- 7 = 16 V
- 8 = 25 V
- 9 = 50 V

(5) CAPACITANCE VALUE

2 significant digits+number of zeros
 The 3rd digit signifies the multiplying factor, and letter R is decimal point
 Example: 121 = 12 × 10¹ = 120 pF

PHYCOMP BRAND ordering codes

GLOBAL PART NUMBER (preferred), PHYCOMP CTC (for North America) and I2NC (traditional) codes are acceptable to order Phycomp brand products.

GLOBAL PART NUMBER (PREFERRED)

For detailed information of GLOBAL PART NUMBER and ordering example, please refer to page 2.

I2NC CODE

Ordering information for 16 V to 25 V

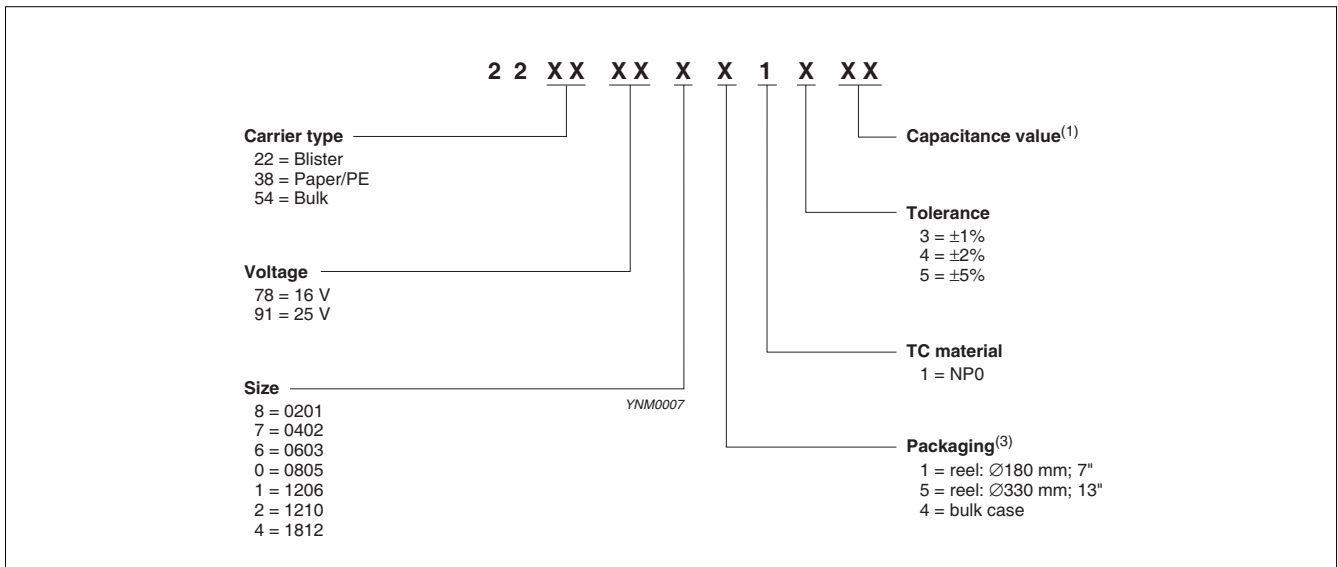

Ordering information for 50 V

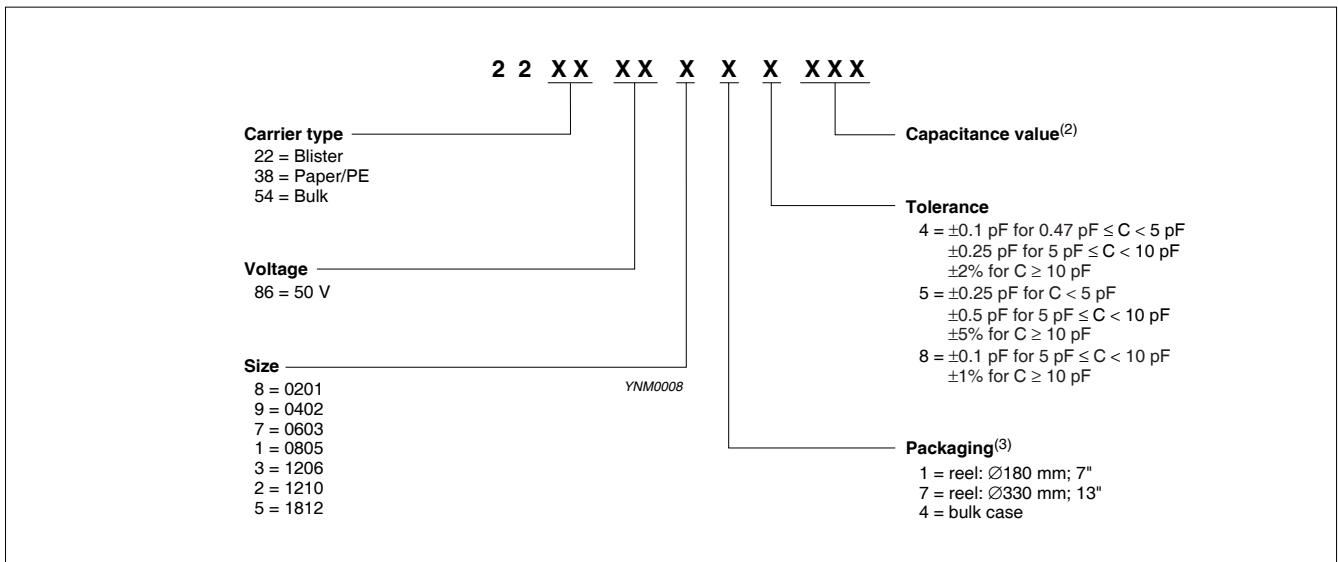

- (1) Please refer to "Last 2-digit of I2NC" in "CAPACITANCE RANGE & THICKNESS FOR NP0"
- (2) Please refer to "Last 3-digit of I2NC" in "CAPACITANCE RANGE & THICKNESS FOR NP0"
- (3) Quantity on reel depends on thickness classification; see table 6

PHYCOMP CTC CODE (FOR NORTH AMERICA)

Example: 0603CG271J7B200

0603	CG	271	J	7	B	2	0	0
Size code	Temp. Char.	Capacitance in pF	Tolerance	Voltage	Termination	Packing	Marking	Range identifier
0201	CG = NPO	101 = 100 pF; the third digit signifies the multiplying factor:	B = ±0.1 pF C = ±0.25 pF D = ±0.5 pF F = ±1% G = ±2% J = ±5%	7 = 16 V 8 = 25 V 9 = 50 V	B = NiSn	2 = 180 mm 7" paper 3 = 330 mm 13" paper	0 = no marking	0 = conv. ceramic
0402						B = 180 mm 7" blister		
0603						F = 330 mm 13" blister		
0805		0 = × 1				P = Bulk case		
1206		1 = × 10						
1210		2 = × 100						
1812		3 = × 1,000						

CONSTRUCTION

The capacitor consists of a rectangular block of ceramic dielectric in which a number of interleaved metal electrodes are contained. This structure gives rise to a high capacitance per unit volume.

The inner electrodes are connected to the two end terminations and finally covered with a layer of plated tin (NiSn). The terminations are lead-free. A cross section of the structure is shown in Fig. 1.

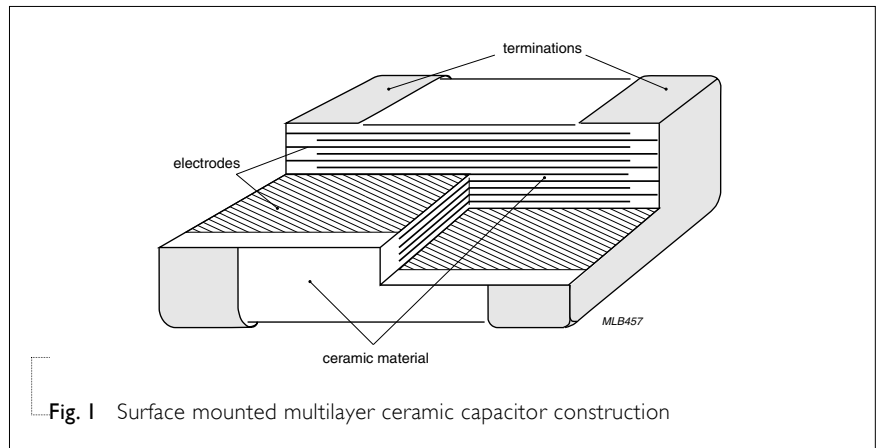

Fig. 1 Surface mounted multilayer ceramic capacitor construction

DIMENSION

Table I For outlines see fig. 2

TYPE	L ₁ (mm)	W (mm)	T (MM)	L ₂ / L ₃ (mm)		L ₄ (mm)
				min.	max.	min.
0201	0.6 ±0.03	0.3 ±0.03	Refer to table 2 to 5	0.10	0.20	0.20
0402	1.0 ±0.05	0.5 ±0.05		0.20	0.30	0.40
0603	1.6 ±0.10	0.8 ±0.10		0.20	0.60	0.40
0805	2.0 ±0.10 ⁽¹⁾	1.25 ±0.10 ⁽¹⁾		0.25	0.75	0.55
	2.0 ±0.20 ⁽²⁾	1.25 ±0.20 ⁽²⁾				
1206	3.2 ±0.15 ⁽¹⁾	1.6 ±0.15 ⁽¹⁾		0.25	0.75	1.40
	3.2 ±0.30 ⁽²⁾	1.6 ±0.20 ⁽²⁾				
1210	3.2 ±0.20	2.5 ±0.20		0.25	0.75	1.40
1812	4.5 ±0.20	3.2 ±0.20		0.25	0.75	2.20

OUTLINES

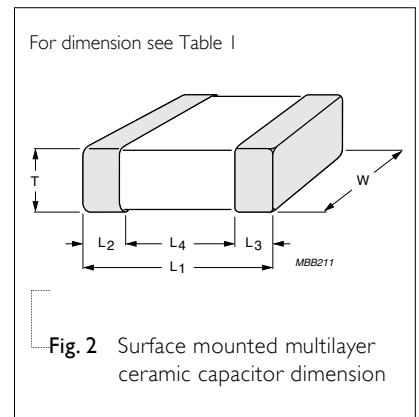

Fig. 2 Surface mounted multilayer ceramic capacitor dimension

NOTE

1. Dimension for size 0805 and 1206, C ≤ 1 nF
2. Dimension for size 0805 and 1206, C > 1 nF

CAPACITANCE RANGE & THICKNESS FOR NP0

Table 2 Sizes from 0201 to 0603

CAP.	Last 3-digit of	Last 2-digit of	0201		0402			0603		
	I2NC	I2NC	25 V	50 V	16 V	25 V	50 V	16 V	25 V	50 V
0.22 pF	227									
0.47 pF	477									
0.82 pF	827									
1.0 pF	108									
1.2 pF	128									
1.5 pF	158									
1.8 pF	188									
2.2 pF	228	On request								
2.7 pF	278									
3.3 pF	338									
3.9 pF	398									
4.7 pF	478									
5.6 pF	568									
6.8 pF	688									
8.2 pF	828			0.3±0.03			0.5±0.05			0.8±0.1
10 pF	109	23								
12 pF	129	24								
15 pF	159	25								
18 pF	189	26								
22 pF	229	27								
27 pF	279	28								
33 pF	339	29	0.3±0.03		0.5±0.05	0.5±0.05		0.8±0.1	0.8±0.1	
39 pF	399	31								
47 pF	479	32								
56 pF	569	33								
68 pF	689	34								
82 pF	829	35								
100 pF	101	36								

NOTE

1. Values in shaded cells indicate thickness class in mm
2. Capacitance value of non E-12 series is on request
3. 16V to 25V, refer to last 2-digit of I2NC
4. 50V, refer to last 3-digit of I2NC

CAPACITANCE RANGE & THICKNESS FOR NP0

Table 3 Sizes from 0201 to 0603 (continued)

CAP.	Last 3-digit of	Last 2-digit of	0201		0402			0603		
	12NC	12NC	25 V	50 V	16 V	25 V	50 V	16 V	25 V	50 V
120 pF	121	37								
150 pF	151	38								
180 pF	181	39								
220 pF	221	41								
270 pF	271	42			0.5±0.05	0.5±0.05	0.5±0.05			
330 pF	331	43								
390 pF	391	44								
470 pF	471	45								
560 pF	561	46						0.8±0.1		
680 pF	681	47							0.8±0.1	0.8±0.1
820 pF	821	48								
1.0 nF	102	49								
1.2 nF	122	51								
1.5 nF	152	52								
1.8 nF	182	53								
2.2 nF	222	54								
2.7 nF	272	55								
3.3 nF	332	56								
3.9 nF	392	57								
4.7 nF	472	58								
5.6 nF	562	59								
6.8 nF	682	61								
8.2 nF	822	62								
10 nF	103	63								
12 nF	123	64								
15 nF	153	65								
18 nF	183	66								
22 nF	223	67								
33 nF	333	69								

NOTE

1. Values in shaded cells indicate thickness class in mm
2. Capacitance value of non E-12 series is on request
3. 16V to 25V, refer to last 2-digit of 12NC
4. 50V, refer to last 3-digit of 12NC

CAPACITANCE RANGE & THICKNESS FOR NP0

Table 4 Sizes from 0805 to 1812

CAP.	Last 3-digit of	Last 2-digit of	0805			1206			1210		1812
	I2NC	I2NC	16 V	25 V	50 V	16 V	25 V	50 V	25 V	50 V	50 V
0.22 pF	227										
0.47 pF	477										
0.82 pF	827										
1.0 pF	108										
1.2 pF	128										
1.5 pF	158										
1.8 pF	188										
2.2 pF	228	On request									
2.7 pF	278										
3.3 pF	338										
3.9 pF	398										
4.7 pF	478										
5.6 pF	568										
6.8 pF	688										
8.2 pF	828				0.6±0.1			0.6±0.1			
10 pF	109	23									
12 pF	129	24									
15 pF	159	25									
18 pF	189	26									
22 pF	229	27									
27 pF	279	28									
33 pF	339	29	0.6±0.1	0.6±0.1		0.6±0.1	0.6±0.1				
39 pF	399	31									
47 pF	479	32									
56 pF	569	33									
68 pF	689	34							0.6±0.1	0.6±0.1	
82 pF	829	35									
100 pF	101	36									

NOTE

1. Values in shaded cells indicate thickness class in mm
2. Capacitance value of non E-12 series is on request
3. 16V to 25V, refer to last 2-digit of I2NC
4. 50V, refer to last 3-digit of I2NC

CAPACITANCE RANGE & THICKNESS FOR NP0

Table 5 Sizes from 0805 to 1812 (continued)

CAP.	Last 3-digit of	Last 2-digit of	0805			1206			1210		1812
	I2NC	I2NC	16 V	25 V	50 V	16 V	25 V	50 V	25 V	50 V	50 V
120 pF	121	37									
150 pF	151	38									
180 pF	181	39									
220 pF	221	41									
270 pF	271	42									
330 pF	331	43									
390 pF	391	44	0.6±0.1	0.6±0.1	0.6±0.1						
470 pF	471	45									
560 pF	561	46				0.6±0.1	0.6±0.1	0.6±0.1	0.6±0.1	0.6±0.1	
680 pF	681	47									
820 pF	821	48									
1.0 nF	102	49									
1.2 nF	122	51									
1.5 nF	152	52	0.85±0.1	0.85±0.1	0.85±0.1						
1.8 nF	182	53									
2.2 nF	222	54									
2.7 nF	272	55									1.25±0.2
3.3 nF	332	56									
3.9 nF	392	57	1.25±0.2	1.25±0.2	1.25±0.2						
4.7 nF	472	58				0.85±0.1	0.85±0.1	0.85±0.1			
5.6 nF	562	59							1.0±0.15	1.0±0.15	
6.8 nF	682	61									
8.2 nF	822	62									
10 nF	103	63									
12 nF	123	64				1.25±0.2	1.25±0.2	1.25±0.2			
15 nF	153	65							1.25±0.2	1.25±0.2	
18 nF	183	66									
22 nF	223	67							2.0±0.2	2.0±0.2	
33 nF	333	69				1.6±0.2					

NOTE

1. Values in shaded cells indicate thickness class in mm
2. Capacitance value of non E-12 series is on request
3. 16V to 25V, refer to last 2-digit of I2NC
4. 50V, refer to last 3-digit of I2NC

THICKNESS CLASSES AND PACKING QUANTITY

Table 6

SIZE CODE	THICKNESS CLASSIFICATION	TAPE WIDTH QUANTITY PER REEL	Ø180 MM / 7 INCH		Ø330 MM / 13 INCH		QUANTITY PER BULK CASE
			Paper	Blister	Paper	Blister	
0201	0.3 ±0.03 mm	8 mm	15,000	---	50,000	---	---
0402	0.5 ±0.05 mm	8 mm	10,000	---	50,000	---	50,000
0603	0.8 ±0.1 mm	8 mm	4,000	---	15,000	---	15,000
0805	0.6 ±0.1 mm	8 mm	4,000	---	20,000	---	10,000
	0.85 ±0.1 mm	8 mm	4,000	---	15,000	---	8,000
	1.25 ±0.2 mm	8 mm	---	3,000	---	10,000	5,000
1206	0.6 ±0.1 mm	8 mm	4,000	---	20,000	---	---
	0.85 ±0.1 mm	8 mm	4,000	---	15,000	---	---
	1.00 / 1.15 ±0.1 mm	8 mm	---	3,000	---	10,000	---
	1.25 ±0.2 mm	8 mm	---	3,000	---	10,000	---
	1.6 ±0.15 mm	8 mm	---	2,500	---	10,000	---
	1.6 ±0.2 mm	8 mm	---	2,000	---	10,000	---
1210	0.6 / 0.7 ±0.1 mm	8 mm	---	4,000	---	15,000	---
	0.85 ±0.1 mm	8 mm	---	4,000	---	10,000	---
	1.15 ±0.1 mm	8 mm	---	3,000	---	10,000	---
	1.15 ±0.15 mm	8 mm	---	3,000	---	10,000	---
	1.25 ±0.2 mm	8 mm	---	3,000	---	---	---
	1.5 ±0.1 mm	8 mm	---	2,000	---	---	---
	1.6 / 1.9 ±0.2 mm	8 mm	---	2,000	---	---	---
	2.0 ±0.2 mm	8 mm	---	2,000 1,000	---	---	---
1808	1.15 ±0.15 mm	12 mm	---	3,000	---	---	---
	1.25 ±0.2 mm	12 mm	---	3,000	---	---	---
	1.35 ±0.15 mm	12 mm	---	2,000	---	---	---
	1.5 ±0.1 mm	12 mm	---	2,000	---	---	---
	1.6 ±0.2 mm	12 mm	---	2,000	---	---	---
	2.0 ±0.2 mm	12 mm	---	2,000	---	---	---
1812	0.6 / 0.85 ±0.1 mm	12 mm	---	2,000	---	---	---
	1.15 ±0.1 mm	12 mm	---	1,000	---	---	---
	1.15 ±0.15 mm	12 mm	---	1,000	---	---	---
	1.35 ±0.15 mm	12 mm	---	1,000	---	---	---
	1.5 ±0.1 mm	12 mm	---	1,000	---	---	---
	1.6 ±0.2 mm	12 mm	---	1,000	---	---	---
	2.0 ±0.2 mm	12 mm	---	1,000	---	---	---
	2.5 ±0.2 mm	12 mm	---	500	---	---	---

ELECTRICAL CHARACTERISTICS

NP0 DIELECTRIC CAPACITORS; NISN TERMINATIONS

Unless otherwise stated all electrical values apply at an ambient temperature of 20 ± 1 °C, an atmospheric pressure of 86 to 106 kPa, and a relative humidity of 63 to 67%.

Table 7

DESCRIPTION	VALUE
Capacitance range	0.22 pF to 33 nF
Capacitance tolerance	
$C < 10$ pF	± 0.1 pF, ± 0.25 pF, ± 0.5 pF
$C \geq 10$ pF	$\pm 1\%$, $\pm 2\%$, $\pm 5\%$
Dissipation factor (D.F.)	
$C < 30$ pF	$\leq 1 / (400 + 20C)$
$C \geq 30$ pF	$\leq 0.1\%$
Insulation resistance after 1 minute at U_r (DC)	$R_{ins} \geq 10$ G Ω or $R_{ins} \times C_r \geq 500$ seconds whichever is less
Maximum capacitance change as a function of temperature (temperature characteristic/coefficient):	± 30 ppm/°C
Operating temperature range:	-55 °C to $+125$ °C

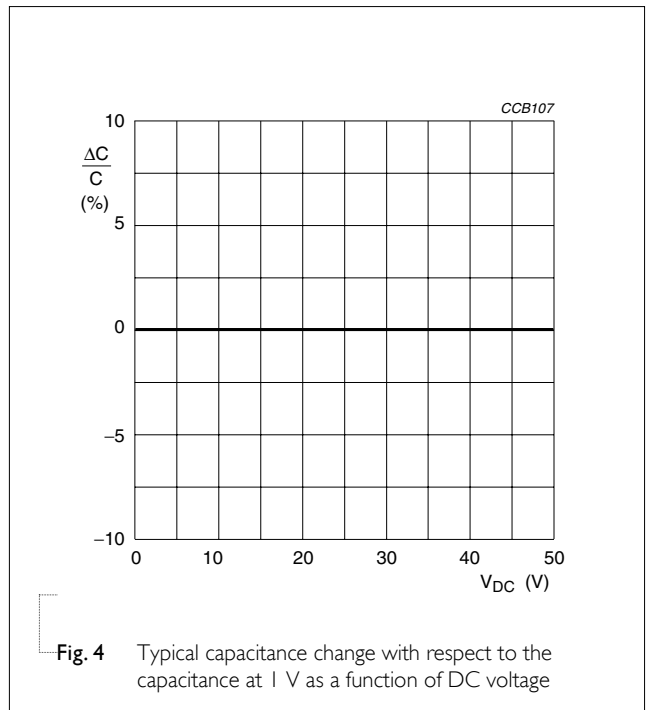
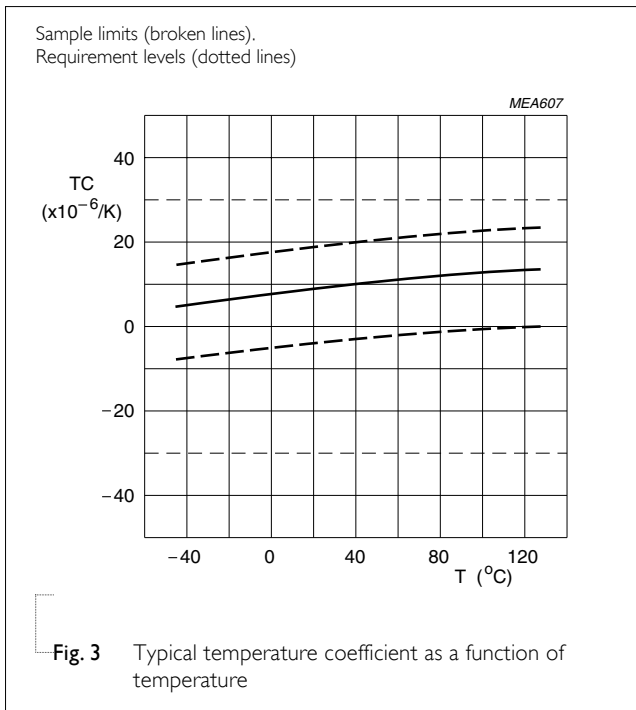

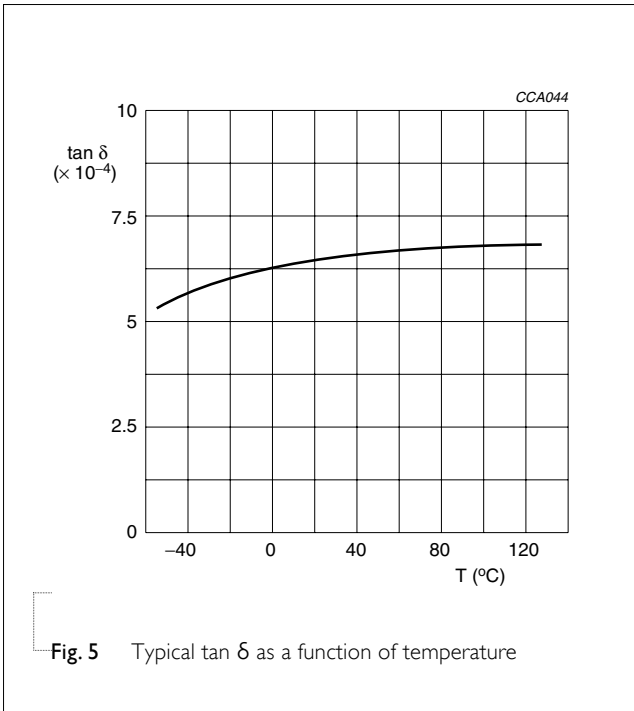

Fig. 5 Typical tan δ as a function of temperature

SOLDERING RECOMMENDATION

Table 8

SOLDERING METHOD	SIZE 0402	0603	0805	1206	≥ 1210
Reflow	≥ 0.1 μF	≥ 1.0 μF	≥ 2.2 μF	≥ 4.7 μF	Reflow only
Reflow/Wave	< 0.1 μF	< 1.0 μF	< 2.2 μF	< 4.7 μF	---

TESTS AND REQUIREMENTS
Table 9 Test procedures and requirements

TEST	TEST METHOD	PROCEDURE	REQUIREMENTS
Mounting	IEC 60384-21/22	4.3 The capacitors may be mounted on printed-circuit boards or ceramic substrates	No visible damage
Visual inspection and dimension check		4.4 Any applicable method using $\times 10$ magnification	In accordance with specification
Capacitance		4.5.1 Class I: $f = 1 \text{ MHz}$ for $C \leq 1 \text{ nF}$, measuring at voltage $1 V_{\text{rms}}$ at $20 \text{ }^\circ\text{C}$ $f = 1 \text{ KHz}$ for $C > 1 \text{ nF}$, measuring at voltage $1 V_{\text{rms}}$ at $20 \text{ }^\circ\text{C}$	Within specified tolerance
Dissipation factor (D.F.)		4.5.2 Class I: $f = 1 \text{ MHz}$ for $C \leq 1 \text{ nF}$, measuring at voltage $1 V_{\text{rms}}$ at $20 \text{ }^\circ\text{C}$ $f = 1 \text{ KHz}$ for $C > 1 \text{ nF}$, measuring at voltage $1 V_{\text{rms}}$ at $20 \text{ }^\circ\text{C}$	In accordance with specification
Insulation resistance		4.5.3 At U_r (DC) for 1 minute	In accordance with specification
Temperature coefficient		4.6 Class I: Between minimum and maximum temperature NP0: $-55 \text{ }^\circ\text{C}$ to $+125 \text{ }^\circ\text{C}$ Normal Temperature: $20 \text{ }^\circ\text{C}$	<General purpose series> $\Delta C/C$: Class I: NP0: $\pm 30 \text{ ppm}/^\circ\text{C}$
Adhesion		4.7 A force applied for 10 seconds to the line joining the terminations and in a plane parallel to the substrate	Force size ≥ 0603 : 5N size = 0402: 2.5N size = 0201: 1N
Bond strength of plating on end face		4.8 Mounting in accordance with IEC 60384-22 paragraph 4.3 Conditions: bending 1 mm at a rate of 1 mm/s, radius jig 340 mm	No visible damage <General purpose series> $\Delta C/C$: Class I: NP0: within $\pm 1\%$ or 0.5 pF whichever is greater

TEST	TEST METHOD	PROCEDURE	REQUIREMENTS
Resistance to soldering heat	IEC 60384-21/22 4.9	<p>Precondition: 150 +0/-10 °C for 1 hour, then keep for 24 ±1 hours at room temperature</p> <p>Preheating: for size ≤ 1206: 120 °C to 150 °C for 1 minute</p> <p>Preheating: for size >1206: 100 °C to 120 °C for 1 minute and 170 °C to 200 °C for 1 minute</p> <p>Solder bath temperature: 260 ±5 °C</p> <p>Dipping time: 10 ±0.5 seconds</p> <p>Recovery time: 24 ±2 hours</p>	<p>Dissolution of the end face plating shall not exceed 25% of the length of the edge concerned</p> <hr/> <p><General purpose series> ΔC/C Class I: NP0: within ±0.5% or 0.5 pF whichever is greater</p> <hr/> <p>D.F. within initial specified value R_{ins} within initial specified value</p>
Solderability	4.10	<p>Preheated the temperature of 80 °C to 140 °C and maintained for 30 seconds to 60 seconds.</p> <p>Test conditions for lead containing solder alloy</p> <p>Temperature: 235 ±5 °C Dipping time: 2 ±0.2 seconds Depth of immersion: 10 mm Alloy Composition: 60/40 Sn/Pb Number of immersions: 1</p> <p>Test conditions for lead-free containing solder alloy</p> <p>Temperature: 245 ±5 °C Dipping time: 3 ±0.3 seconds Depth of immersion: 10 mm Alloy Composition: SAC305 Number of immersions: 1</p>	<p>The solder should cover over 95% of the critical area of each termination</p>
Rapid change of temperature	4.11	<p>Preconditioning: 150 +0/-10 °C for 1 hour, then keep for 24 ±1 hours at room temperature</p> <p>5 cycles with following detail: 30 minutes at lower category temperature 30 minutes at upper category temperature</p> <p>Recovery time 24 ±2 hours</p>	<p>No visual damage</p> <hr/> <p><General purpose series> ΔC/C Class I: NP0: within ±1% or 1 pF whichever is greater</p> <hr/> <p>D.F. meet initial specified value R_{ins} meet initial specified value</p>

TEST	TEST METHOD	PROCEDURE	REQUIREMENTS
Damp heat with U_r load	IEC 60384-21/22 4.13	<ol style="list-style-type: none"> Preconditioning, class 2 only: 150 +0/-10 °C /1 hour, then keep for 24 ±1 hour at room temp Initial measure: Spec: refer to initial spec C, D, IR Damp heat test: 500 ±12 hours at 40 ±2 °C; 90 to 95% R.H. 1.0 U_r applied Recovery: Class I: 6 to 24 hours Final measure: C, D, IR <p>P.S. If the capacitance value is less than the minimum value permitted, then after the other measurements have been made the capacitor shall be preconditioned according to "IEC 60384 4.1" and then the requirement shall be met.</p>	<p>No visual damage after recovery</p> <hr/> <p><General purpose series> $\Delta C/C$ Class I: NP0: within ±2% or 1 pF whichever is greater D.F. Class I: NP0: ≤ 2 x specified value R_{ins} Class I: NP0: ≥ 2,500 MΩ or $R_{ins} \times C_r \geq 25s$ whichever is less</p>
Endurance	4.14	<ol style="list-style-type: none"> Preconditioning, class 2 only: 150 +0/-10 °C /1 hour, then keep for 24 ±1 hour at room temp Initial measure: Spec: refer to initial spec C, D, IR Endurance test: Temperature: NP0: 125 °C Specified stress voltage applied for 1,000 hours: Applied 2.0 x U_r for general product. Recovery time: 24 ±2 hours Final measure: C, D, IR <p>P.S. If the capacitance value is less than the minimum value permitted, then after the other measurements have been made the capacitor shall be preconditioned according to "IEC 60384 4.1" and then the requirement shall be met.</p>	<p>No visual damage</p> <hr/> <p><General purpose series> $\Delta C/C$ Class I: NP0: within ±2% or 1 pF whichever is greater D.F. Class I: NP0: ≤ 2 x specified value R_{ins} Class I: NP0: ≥ 4,000 MΩ or $R_{ins} \times C_r \geq 40s$ whichever is less</p>
Voltage proof	IEC 60384-1 4.6	<p>Specified stress voltage applied for 1 minute</p> <p>$U_r \leq 100$ V: series applied 2.5 U_r 100 V < $U_r \leq 200$ V series applied (1.5 U_r + 100) 200 V < $U_r \leq 500$ V series applied (1.3 U_r + 100) $U_r > 500$ V: 1.3 U_r I: 7.5 mA</p>	No breakdown or flashover

REVISION HISTORY

REVISION	DATE	CHANGE NOTIFICATION	DESCRIPTION
Version 6	Jan 06, 2011	-	- Dimension updated
Version 5	Dec 29, 2010	-	- Dimension updated
Version 4	Nov 23, 2010	-	- Dimension updated
Version 3	Apr 20, 2010	-	- The statement of "Halogen Free" on the cover added - Dimension updated
Version 2	Oct 26, 2009	-	- Typo updated
Version 1	Jun 02, 2009	-	- I2NC code updated
Version 0	Apr 15, 2009	-	- New datasheet for general purpose NP0 series with RoHS compliant - Replace the "16V to 50V" part of pdf files: NP0_16V_7, NP0_16V-to-100V_6, NP0_25V_7, NP0_50-to-500V_1 I - Combine 020I from pdf files: UP-NP0X5RX7RY5V_020I_6.3-to-50V_2 and UY-NPOX5RX7RY5V_020I_6.3-to-50V_2 - Define global part number - Description of "Halogen Free compliant" added - Test method and procedure updated