



Positronic Industries
connectpositronic.com

PROFESSIONAL QUALITY, FIXED CONTACT SUBMINIATURE-D CONNECTORS

D-Sub

FOR SHELTERED INDOOR/OUTDOOR ENVIRONMENTAL APPLICATIONS

Size 20 Contacts, Fixed Professional Quality Connectors

IEC Publication 807-2 Performance Level Two

U.L. Recognized
File #E49351

CSA Recognized
File #LR54219

Telecommunication
U.L. File #14098

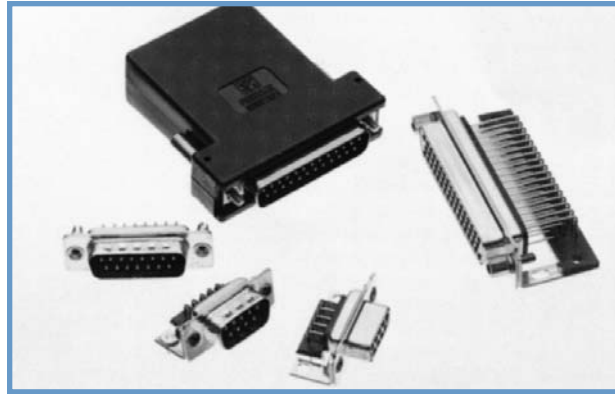

Melo-D and Euro-D Series connectors are professional quality connectors recommended for use in sheltered, non-corrosive indoor or outdoor environments having normal ventilation, but without temperature or humidity controls. These fixed contact connectors meet the dimensional and performance requirements of IEC 807-2, Performance Level Two.

Melo-D and Euro-D Series connectors utilize precision machined contacts which are fixed within the connector body. The female contact is an open entry design contact, precision machined of high tensile phosphor bronze.

Six standard connector variants are offered in arrangements of 9, 15, 25, 29, 37 and 50 contacts. Each Melo-D connector variant is available with contact terminations for solder cup, wrap post, and straight and 90° printed board mount terminations featuring a choice of three printed board footprints. Each Euro-D connector variant is available with contact terminations for solder cup, wrap post and straight and 90° printed board mount terminations per standard European metric footprints. Melo-D and Euro-D

Series connectors are mateable and compatible with all D-Subminiature connectors conforming to IEC 807-2 and MIL-DTL-24308.

A wide assortment of printed board mounting hardware, cable support hoods and locking systems is available from stock.

Melo-D and Euro-D Series connectors conform to EIA RS 232 and RS 449, and CCITT X.24 interface connector requirements.



Contact Technical
Sales for details.

MELO-D/EURO-D SERIES TECHNICAL CHARACTERISTICS

MATERIALS AND FINISHES:

Insulator:	Nylon resin, UL 94V-0, black color.
Contacts:	Male contacts – precision machined brass. Female contacts – precision machined high tensile phosphor bronze.
Contact Plating:	Professional performance Gold flash over nickel plate. Other finishes available upon request.
Shells:	Steel with tin plate; zinc plate with dichromate seal. Other materials and finishes available upon request.
Mounting Spacers and Brackets:	Nylon plastic, or brass with tin plate; zinc plate with dichromate seal.
Push-On Fasteners:	Phosphor bronze or beryllium copper with tin plate.
Jackscrew Systems:	Steel with zinc plate and dichromate seal, or clear zinc plate.
Vibration Lock Systems:	Slide lock and lock tabs, steel with nickel plate.
Hoods:	Thermoplastic UL 94V-0. Composite, brass or steel with zinc plate and dichromate seal.

ELECTRICAL CHARACTERISTICS:

Contact Current Rating:	7.5 amperes nominal.
Initial Contact Resistance:	0.008 ohms maximum.
Insulator Resistance:	5 G ohms.
Proof Voltage:	1000 V r.m.s.
Clearance and Creepage Distance [minimum]:	0.039 inch [1.0mm].
Working Voltage:	300 V r.m.s.

CLIMATIC CHARACTERISTICS:

Temperature Range:	-55°C to +125°C.
Damp Heat, Steady State:	10 days.

MECHANICAL CHARACTERISTICS:

Fixed Contacts:	Size 20 contact, male contact - 0.040 inch [1.02mm] diameter. Female contact - rugged open entry design.
Contact Retention In Insulator:	6 lbs. [27N]
Resistance To Solder Iron Heat:	500°F [260°C] for 10 seconds duration per IEC 512-6.
Melo-D Contact Terminations:	Solder cup contacts – 0.042 inch [1.06mm] minimum hole diameter for 20 AWG [0.5mm ²] wire maximum. Straight Printed Board Mount – 0.028 inch [0.71mm] diameter. 90° Printed Board Mount – 0.028 inch [0.71mm] diameter for all printed board footprints.
Euro-D Contact Terminations:	Wrap Post – 0.025 inch [0.64mm] square. Solder cup contacts – 0.042 inch [1.06mm] minimum hole diameter for 20 AWG [0.5mm ²] wire maximum. Straight Printed Board Mount – 0.024 inch [0.60mm] diameter. 90° Printed Board Mount – 0.024 inch [0.60mm] diameter for European Metric Footprints.
Shells:	Male shells may be dimpled for EMI/ESD ground paths.
Polarization:	Trapezoidally shaped shells and polarized jackscrews.
Mounting To Angle Brackets:	Jackscrews and riveted fasteners with a 0.120 inch [3.05mm] clearance hole, and threaded riveted fasteners with 4-40 threads and nylon lock inserts.
Mounting To Printed Board:	Rapid installation push-on fasteners and threaded posts.
Locking Systems:	Jackscrews and vibration locking systems.
Mechanical Operations:	500 operations minimum per IEC 512-5.



CONTACT VARIANTS
FACE VIEW OF MALE OR REAR VIEW OF FEMALE

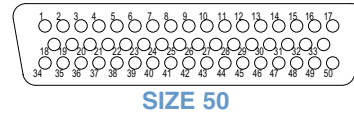
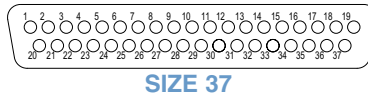
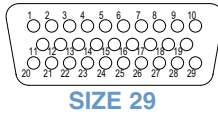
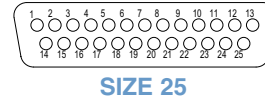
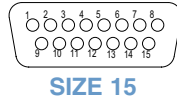
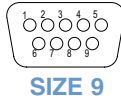

STANDARD SHELL ASSEMBLY

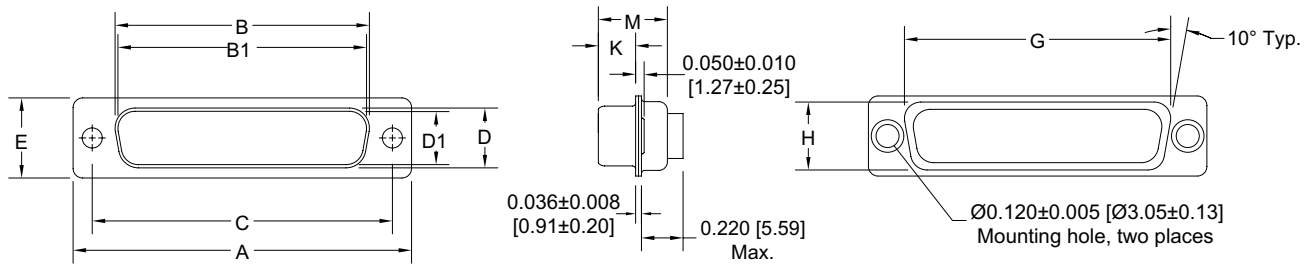

OPTIONAL SHELL ASSEMBLY [0, 02]

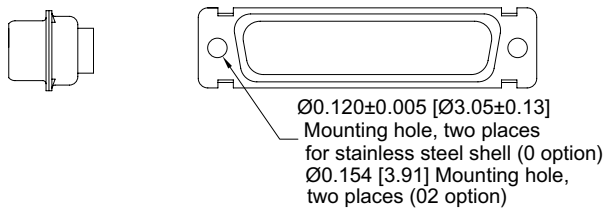

OPTIONAL SHELL ASSEMBLY WITH UNIVERSAL FLOAT MOUNTS [F]

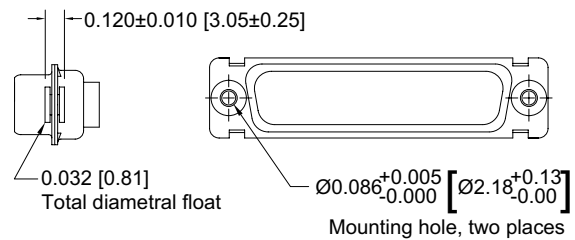

CONNECTOR VARIANT SIZES	A ±0.015 [0.38]	B ±0.005 [0.13]	B1 ±0.005 [0.13]	C ±0.005 [0.13]	D ±0.005 [0.13]	D1 ±0.005 [0.13]	E ±0.015 [0.38]	G ±0.010 [0.25]	H ±0.010 [0.25]	K ±0.005 [0.13]	M ±0.010 [0.25]
9 M	1.213 [30.81]		0.666 [16.92]	0.984 [24.99]		0.329 [8.36]	0.494 [12.55]	0.759 [19.28]	0.422 [10.72]	0.233 [5.92]	0.422 [10.72]
9 F	1.213 [30.81]	0.643 [16.33]		0.984 [24.99]	0.311 [7.90]		0.494 [12.55]	0.759 [19.28]	0.422 [10.72]	0.243 [6.17]	0.429 [10.90]
15 M	1.541 [39.14]		0.994 [25.25]	1.312 [33.32]		0.329 [8.36]	0.494 [12.55]	1.083 [27.51]	0.422 [10.72]	0.233 [5.92]	0.422 [10.72]
15 F	1.541 [39.14]	0.971 [24.66]		1.312 [33.32]	0.311 [7.90]		0.494 [12.55]	1.083 [27.51]	0.422 [10.72]	0.243 [6.17]	0.429 [10.90]
25 M	2.088 [53.04]		1.534 [38.96]	1.852 [47.04]		0.329 [8.36]	0.494 [12.55]	1.625 [41.28]	0.422 [10.72]	0.230 [5.84]	0.426 [10.82]
25 F	2.088 [53.04]	1.511 [38.38]		1.852 [47.04]	0.311 [7.90]		0.494 [12.55]	1.625 [41.28]	0.422 [10.72]	0.243 [6.17]	0.429 [10.90]
29 M	1.770 [44.96]		1.274 [32.36]	1.534 [38.96]		0.450 [11.43]	0.605 [15.37]	1.322 [33.58]	0.539 [13.69]	0.217 [5.51]	0.426 [10.82]
29 F	1.770 [44.96]	1.251 [31.78]		1.534 [38.96]	0.431 [10.95]		0.605 [15.37]	1.322 [33.58]	0.539 [13.69]	0.237 [6.02]	0.429 [10.90]
37 M	2.729 [69.32]		2.182 [55.42]	2.500 [63.50]		0.329 [8.36]	0.494 [12.55]	2.272 [57.71]	0.422 [10.72]	0.230 [5.84]	0.426 [10.82]
37 F	2.729 [69.32]	2.159 [54.84]		2.500 [63.50]	0.311 [7.90]		0.494 [12.55]	2.272 [57.71]	0.422 [10.72]	0.243 [6.17]	0.429 [10.90]
50 M	2.635 [66.93]		2.079 [52.81]	2.406 [61.11]		0.441 [11.20]	0.605 [15.37]	2.178 [55.32]	0.534 [13.56]	0.230 [5.84]	0.426 [10.82]
50 F	2.635 [66.93]	2.064 [52.43]		2.406 [61.11]	0.423 [10.74]		0.605 [15.37]	2.178 [55.32]	0.534 [13.56]	0.243 [6.17]	0.429 [10.90]



Positronic Industries
connectpositronic.com

PROFESSIONAL QUALITY, FIXED CONTACT SUBMINIATURE-D CONNECTORS

D-Sub

FOR SHELTERED INDOOR/OUTDOOR ENVIRONMENTAL APPLICATIONS

SOLDER CUP CONNECTOR

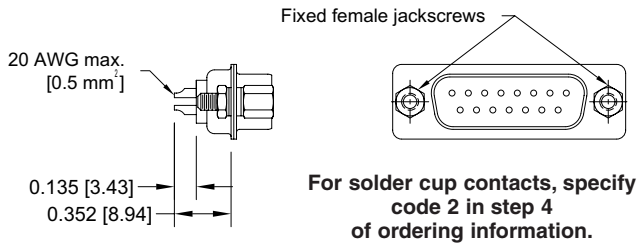

Typical Part Number: ED15M200T2Z

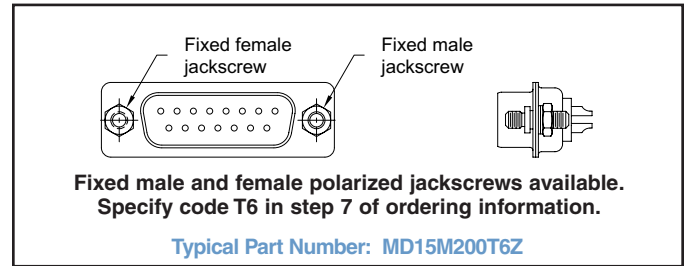

Typical Part Number: MD15M200T6Z

STRAIGHT PRINTED BOARD MOUNT CONNECTOR

CODE NUMBER	L	ØD
3	0.150 [3.81]	0.028 [0.71]
32	0.375 [9.53]	0.028 [0.71]
36	0.236 [5.99]	0.024 [0.61]

For straight printed board mount contacts, specify code number in step 4 of ordering information.

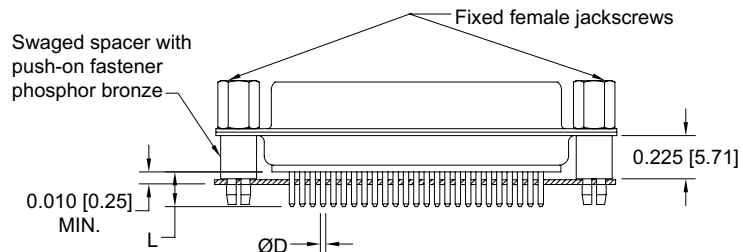

Typical Part Number: MD25F3S60T0

FERRITE INDUCTOR BAR FOR EMI/RFI NOISE SUPPRESSION

FILTERING CHARACTERISTICS

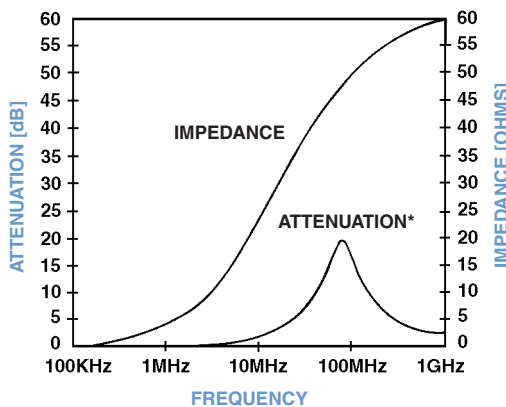

MATERIAL: NICKEL ZINC CERAMIC.

SERIES	CODE NO.	A	L
MD	32	0.375 [9.53]	0.240 [6.10]
MD	4	-----	-----
MD	59	-----	-----
MD	6	0.375 [9.53]	0.360 [9.14]
ED	36	0.375 [9.53]	0.101 [2.57]
ED	6	0.375 [9.53]	0.360 [9.14]
DD	32	0.515 [13.08]	0.165 [4.19]
ODD	32	0.375 [9.53]	0.165 [4.19]
ODD	5	-----	-----
HDC	32	0.375 [9.53]	0.240 [6.10]
HDC	36	0.375 [9.53]	0.101 [2.57]
HDC	6	0.375 [9.53]	0.360 [9.14]

Specify code F or Q in step 6 of ordering information. F for ferrite inductor and Q for ferrite inductor with push-on fastener.

STRAIGHT PRINTED BOARD MOUNT CONNECTOR

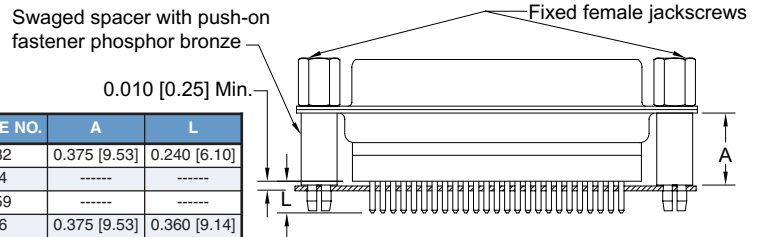

90° PRINTED BOARD MOUNT CONNECTOR

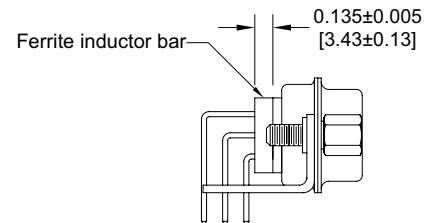

WRAP POST CONNECTOR

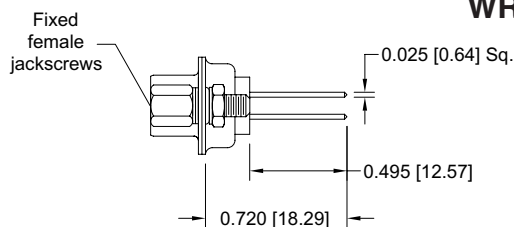

Typical Part Number: MD15F600T20

For wrap post contacts, specify code 6 in step 4 of ordering information.

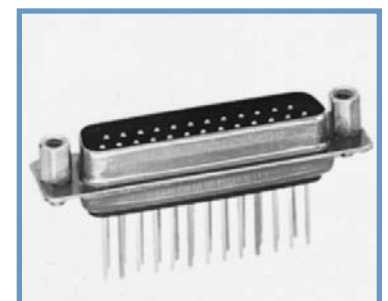

MD25M6S50T0



90° PRINTED BOARD MOUNT CONNECTOR
CODE 5, 0.283 [7.19] CONTACT EXTENSION

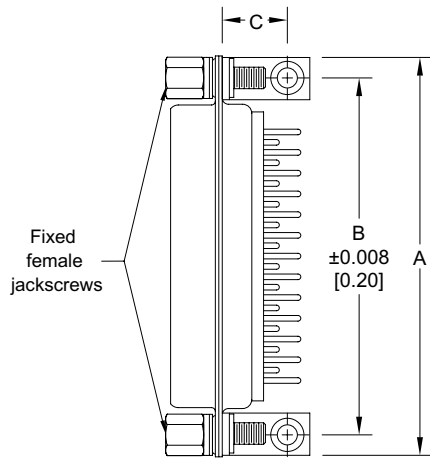

MD**5R4*** 0.283 [7.19] CONTACT EXTENSION				
PART NUMBER	A	B	C	D
MD9*5R4***	1.204 [30.58]	0.984 [24.99]	0.339 [8.61]	0.283 [7.19]
MD15*5R4***	1.532 [38.91]	1.312 [33.32]	0.339 [8.61]	0.283 [7.19]
MD25*5R4***	2.072 [52.63]	1.852 [47.04]	0.339 [8.61]	0.283 [7.19]
MD29*5R4***	1.754 [44.55]	1.534 [38.96]	0.395 [10.03]	0.283 [7.19]
MD37*5R4***	2.720 [69.09]	2.500 [63.50]	0.339 [8.61]	0.283 [7.19]
MD50*5R4***	2.626 [66.70]	2.406 [61.11]	0.395 [10.03]	0.283 [7.19]

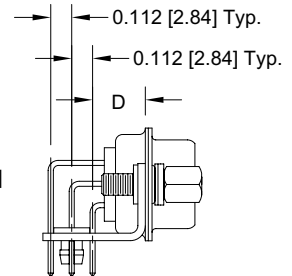
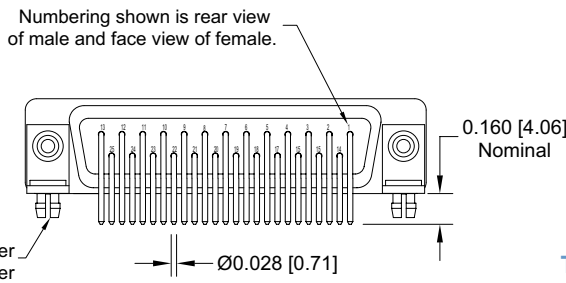
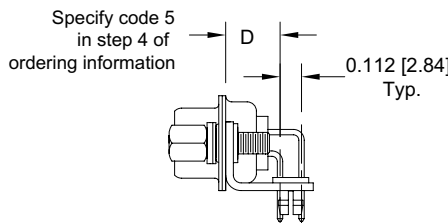

Typical Part Number:
MD25M5R4NT2X

Push-on fastener
beryllium copper

Typical Part Number:
MD50M5R4NT2X

90° PRINTED BOARD MOUNT CONNECTOR
CODE 59, 0.545 [13.84] CONTACT EXTENSION

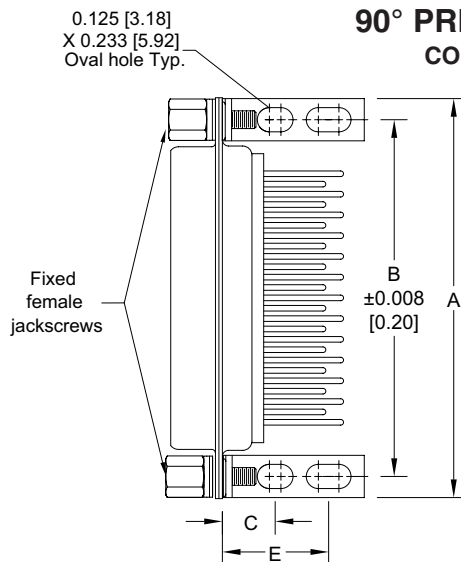

MD**59B*** 0.545 [13.84] CONTACT EXTENSION					
PART NUMBER	A	B	C	D	E
MD9*59B***	1.204 [30.58]	0.984 [24.99]	0.275 [6.99]	0.545 [13.84]	0.601 [15.27]
MD15*59B***	1.532 [38.91]	1.312 [33.32]	0.275 [6.99]	0.545 [13.84]	0.601 [15.27]
MD25*59B***	2.072 [52.63]	1.852 [47.04]	0.275 [6.99]	0.545 [13.84]	0.601 [15.27]
MD29*59B***	1.754 [44.55]	1.534 [38.96]	0.275 [6.99]	0.545 [13.84]	0.657 [16.69]
MD37*59B***	2.720 [69.09]	2.500 [63.50]	0.275 [6.99]	0.545 [13.84]	0.601 [15.27]
MD50*59B***	2.626 [66.70]	2.406 [61.11]	0.275 [6.99]	0.545 [13.84]	0.657 [16.69]

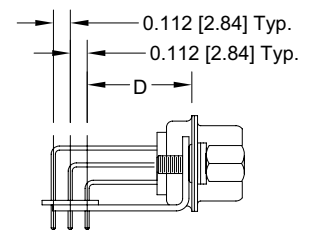
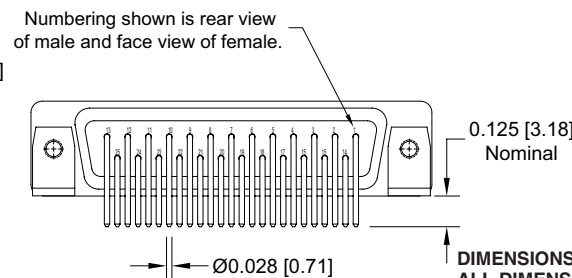
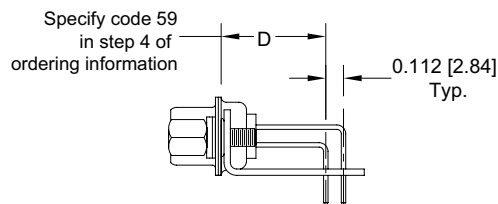

Typical Part Number:
MD25M59B0T2X

DIMENSIONS ARE IN INCHES [MILLIMETERS].
ALL DIMENSIONS ARE SUBJECT TO CHANGE.



Positronic Industries
connectpositronic.com

PROFESSIONAL QUALITY, FIXED CONTACT SUBMINIATURE-D CONNECTORS

D-Sub

FOR SHELTERED INDOOR/OUTDOOR ENVIRONMENTAL APPLICATIONS

90° PRINTED BOARD MOUNT CONNECTOR CODE 4, 0.450 [11.43] CONTACT EXTENSION

MD / ED SERIES

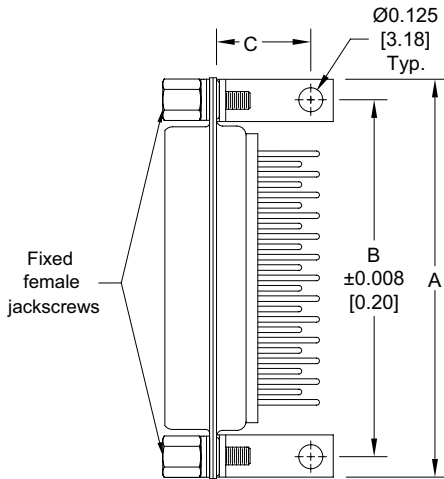

MD**4B*** 0.450 [11.43] CONTACT EXTENSION				
PART NUMBER	A	B	C	D
MD9*4B***	1.204 [30.58]	0.984 [24.99]	0.506 [12.85]	0.450 [11.43]
MD15*4B***	1.532 [38.91]	1.312 [33.32]	0.506 [12.85]	0.450 [11.43]
MD25*4B***	2.072 [52.63]	1.852 [47.04]	0.506 [12.85]	0.450 [11.43]
MD29*4B***	1.754 [44.55]	1.534 [38.96]	0.562 [14.27]	0.450 [11.43]
MD37*4B***	2.720 [69.09]	2.500 [63.50]	0.506 [12.85]	0.450 [11.43]
MD50*4B***	2.626 [66.70]	2.406 [61.11]	0.562 [14.27]	0.450 [11.43]

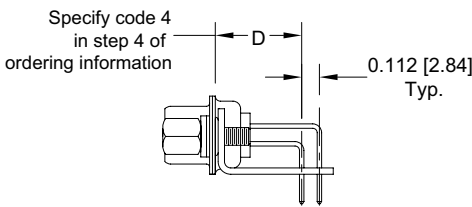

Typical Part Number:
MD25M4B0T20

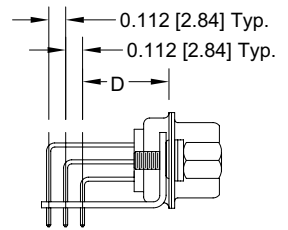
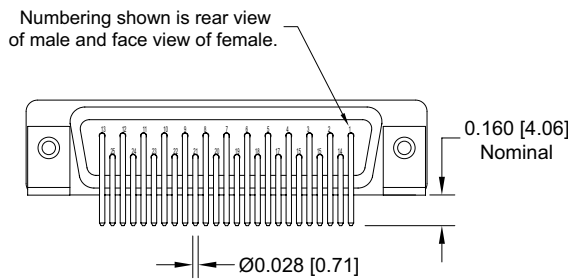

Typical Part Number:
MD50M4B0T20

90° AND STRAIGHT PRINTED BOARD CONTACT HOLE PATTERN

Mount connector with mating face positioned to follow direction of arrow.

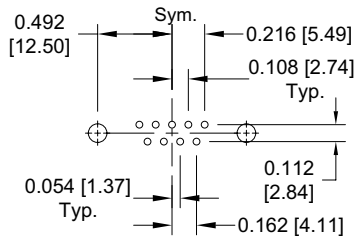

MD9

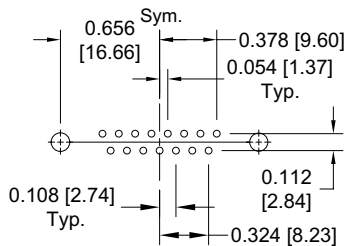

MD15

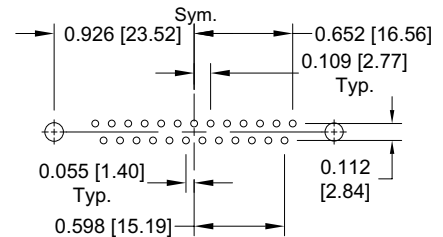

MD25

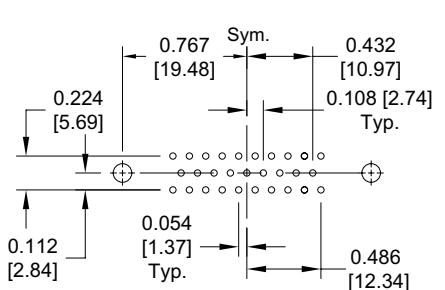

MD29

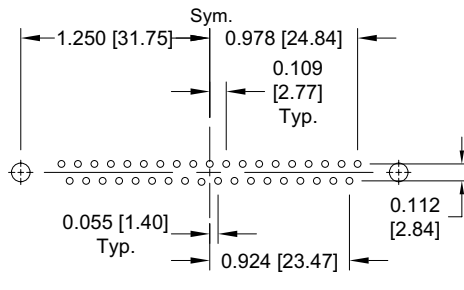

MD37

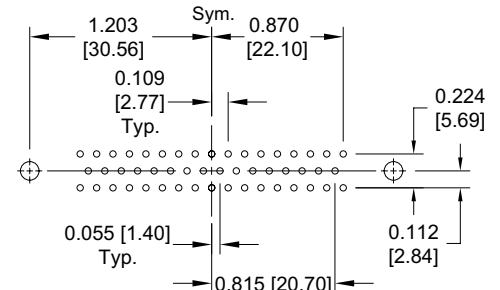

MD50

7 DIMENSIONS ARE IN INCHES [MILLIMETERS].
ALL DIMENSIONS ARE SUBJECT TO CHANGE.

Suggest 0.045 [1.14] Ø hole for contact termination positions.
Suggest 0.123 ±0.003 [3.12 ±0.08] Ø hole for mounting connector with push-on fasteners.



90° PRINTED BOARD MOUNT CONNECTOR
CODE 42 AND 52, 0.370 [9.40] CONTACT EXTENSION

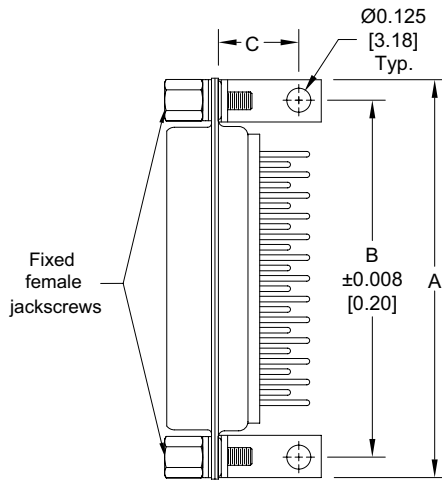

ED***B*** 0.370 [9.40] CONTACT EXTENSION				
PART NUMBER	A	B	C	D
ED9**B***	1.204 [30.58]	0.984 [24.99]	0.420 [10.67]	0.370 [9.40]
ED15**B***	1.532 [38.91]	1.312 [33.32]	0.420 [10.67]	0.370 [9.40]
ED25**B***	2.072 [52.63]	1.852 [47.04]	0.420 [10.67]	0.370 [9.40]
ED29**B***	1.754 [44.55]	1.534 [38.96]	0.470 [11.94]	0.370 [9.40]
ED37**B***	2.720 [69.09]	2.500 [63.50]	0.420 [10.67]	0.370 [9.40]
ED50**B***	2.626 [66.70]	2.406 [61.11]	0.470 [11.94]	0.370 [9.40]

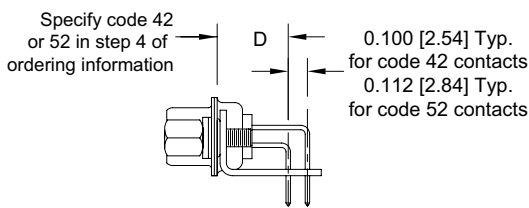

Typical Part Number:
ED25M42B0T2X

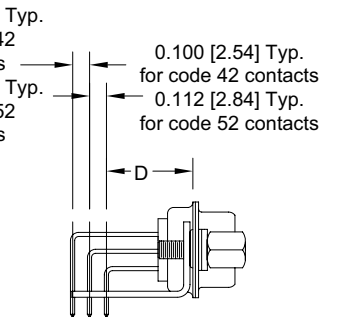
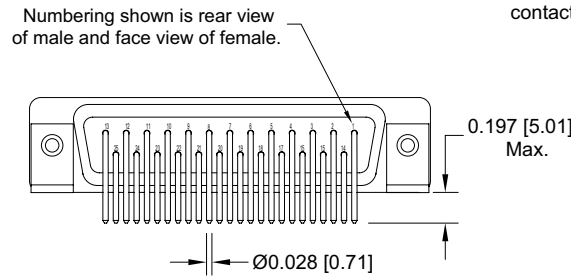

Typical Part Number:
ED50M52B0T2X

90° PRINTED BOARD MOUNT CONNECTOR
CODE 44, 0.370 [9.40] CONTACT EXTENSION

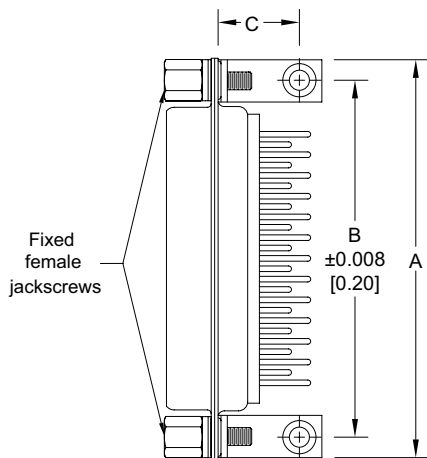

ED**44B*** 0.370 [9.40] CONTACT EXTENSION				
PART NUMBER	A	B	C	D
ED9*44B***	1.204 [30.58]	0.984 [24.99]	0.420 [10.67]	0.370 [9.40]
ED15*44B***	1.532 [38.91]	1.312 [33.32]	0.420 [10.67]	0.370 [9.40]
ED25*44B***	2.072 [52.63]	1.852 [47.04]	0.420 [10.67]	0.370 [9.40]
ED29*44B***	1.754 [44.55]	1.534 [38.96]	0.470 [11.94]	0.370 [9.40]
ED37*44B***	2.720 [69.09]	2.500 [63.50]	0.420 [10.67]	0.370 [9.40]
ED50*44B***	2.626 [66.70]	2.406 [61.11]	0.470 [11.94]	0.370 [9.40]

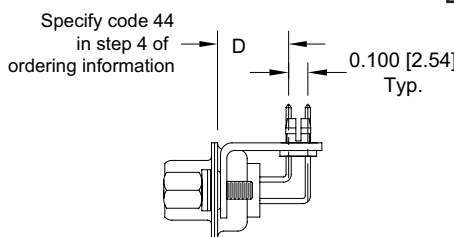

Typical Part Number:
ED25M44BNT2X

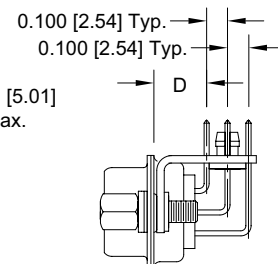
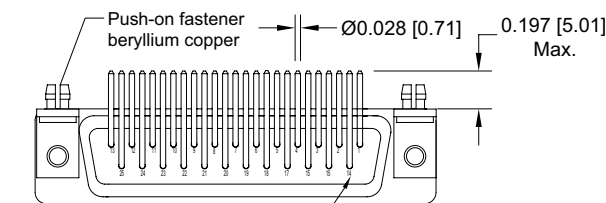

Typical Part Number:
ED29M44BNT2X

DIMENSIONS ARE IN INCHES [MILLIMETERS].
ALL DIMENSIONS ARE SUBJECT TO CHANGE.



90° AND STRAIGHT PRINTED BOARD
CONTACT HOLE PATTERN

Hole identification shown for male connector, use mirror image for female connector.

For code 42 and 52 contacts, mount connector with mating face positioned to follow direction of arrow.

For code 44 contacts, mount connector with mating face positioned to oppose direction of arrow.

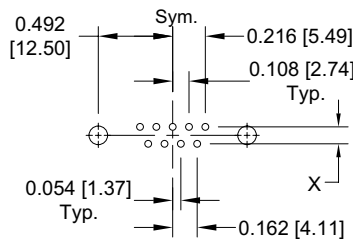

ED9

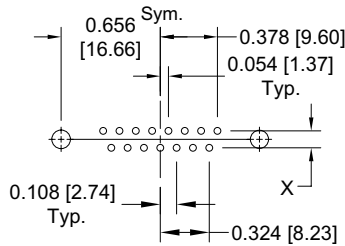

ED15

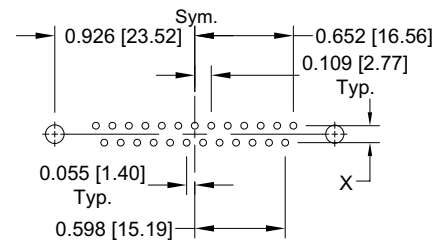

ED25

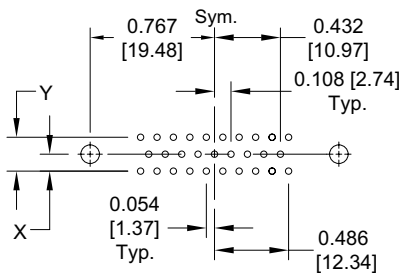

ED29

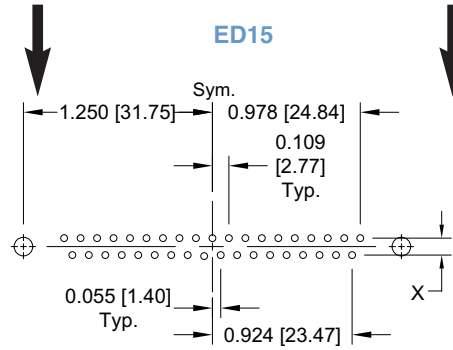

ED37

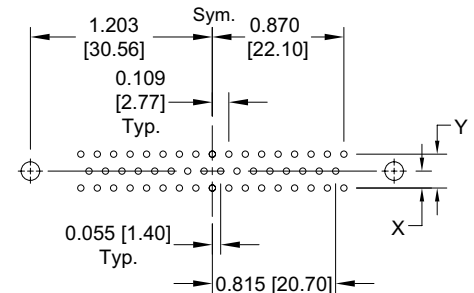

ED50

Suggest 0.040 [1.02] Ø hole for contact termination positions.

Suggest 0.123 ±0.003 [3.12 ±0.08] Ø hole for mounting connector with push-on fasteners.

CODE NUMBER	X	Y
36	0.112 [2.84]	0.224 [5.69]
42	0.100 [2.54]	0.200 [5.08]
44	0.100 [2.54]	0.200 [5.08]
52	0.112 [2.84]	0.224 [5.69]



ORDERING INFORMATION - CODE NUMBERING SYSTEM

MELO-D SERIES

STEP	1	2	3	4	5	6	7	8	9
EXAMPLE	MD	25	F	59	R7	N	T6	X	

Specify Complete Connector By
Selecting An Option From
Step 1 Through 8

STEP 1 - BASIC SERIES

MD Series

STEP 2 - CONNECTOR VARIANTS

9, 15, 25, 29, 37, 50

STEP 3 - CONNECTOR GENDER

M - Male
F - Female

STEP 4 - CONTACT TERMINATION

- 2 - Solder cup.
- 3 - Solder, Straight Printed Board Mount with 0.150 [3.81] Tail Length.
- 32 - Solder, Straight Printed Board Mount with 0.375 [9.52] Tail Length.
- 4 - Solder, 90° Printed Board Mount with 0.450 [11.43] Contact Extension.
- 5 - Solder, 90° Printed Board Mount with 0.283 [7.19] Contact Extension.
- 59 - Solder, 90° Printed Board Mount with 0.545 [13.84] Contact Extension.
- 6 - Wrap Post.

*STEP 5 - MOUNTING STYLE

- 0 - Mounting Hole, 0.120 [3.05] Ø.
- 02 - Mounting Hole, 0.154 [3.91] Ø.
- B - Bracket, Mounting, 90° Metal.
- B3 - Bracket, Mounting, 90° Metal with Cross Bar.
- B7 - Bracket, Mounting, 90° Plastic.
- B8 - Bracket, Mounting, 90° Plastic with Cross Bar.
- F - Float Mounts, Universal.
- P - Threaded Post, Brass, 0.225 [5.71] Length.
- P2 - Threaded Post, Nylon, 0.225 [5.71] Length.
- R - Bracket, Mounting, 90° Metal, Swaged to Connector with 4-40 Thread Fixed Female Jackscrews.
- R2 - Bracket, Mounting, 90° Metal, Swaged to Connector with 4-40 Thread Fixed Female Jackscrews with Cross Bar.
- R3 - Bracket, Mounting, 90° Metal, Swaged to Connector with 0.120 [3.05] Ø Mounting Hole.
- R4 - Bracket, Mounting, 90° Metal, Swaged to Connector with 4-40 Threads.
- R5 - Bracket, Mounting, 90° Metal, Swaged to Connector with 4-40 Locknut.
- R6 - Bracket, Mounting, 90° Metal, Swaged to Connector with 0.120 [3.05] Ø Mounting Hole with Cross Bar.
- R7 - Bracket, Mounting, 90° Metal, Swaged to Connector with 4-40 Threads with Cross Bar.
- R8 - Bracket, Mounting, 90° Metal, Swaged to Connector with 4-40 Locknut with Cross Bar.
- S - Swaged Spacer, 4-40 Threads, 0.225 [5.71] Length.
- S2 - Swaged Spacer, 4-40 Threads, 0.125 [3.18] Length.
- S5 - Swaged Locknut, 4-40 Threads.
- S6 - Swaged Spacer with Push-on Fastener, 4-40 Threads, 0.225 [5.71] Length.
- S7 - Swaged Spacer with Push-on Fastener for use with Ferrite Inductor, 4-40 Threads, 0.375 [9.53] Length.

*For additional information on accessories listed in steps 5, 6 and 7, see Accessory Catalog.

**Ferrite inductor is available on contact types 32, 4, 59 and 6 only.

STEP 9 - SPECIAL OPTIONS

Contact Technical Sales for Special Options

STEP 8 - Shell Options

- 0 - Zinc Plated, with Dichromate Seal.
- X - Tin Plated.
- Z - Tin Plated and Dimpled (male connectors only).

*STEP 7 - LOCKING AND POLARIZING SYSTEMS

- 0 - None.
- V3 - Lock Tab, connector front panel mounted.
- V5 - Lock Tab, connector rear panel mounted.
- VL - Lock Lever, used with Hoods only.
- T - Fixed Female Jackscrews.
- T2 - Fixed Female Jackscrews.
- T6 - Fixed Male and Female Polarized Jackscrews.
- E - Rotating Male Jackscrews.
- E2 - Rotating Male Screw Locks.
- E3 - Internal hex for 3/32 hex drives
- E6 - Rotating Male and Female Polarized Jackscrews.

*STEP 6 - HOODS AND PUSH-ON FASTENERS

- 0 - None.
- J - Hood, Top Opening, Plastic.
- L - Hood, Side Opening, Plastic.
- Y - Hood, Top Opening, Plastic with Rotating Male Jackscrews. Available in size 50 only.
- Y6 - Hood, Top Opening, Plastic with Rotating Male and Female Polarized Jackscrews. Available in size 50 only.
- Z - Hood, Top or Side Opening, Robust and Extended Height, Composite and Plastic with Rotating Male Jackscrews. Available in size 9, 15, 25, 37, and 50 only.
- H - Hood, Top Opening, Metal. Available in size 15, 25, 37, and 50 only.
- G - Hood, EMI/RFI, Metal. Available in size 9, 15, 25, 37, and 50 only.
- W - Hood, Top or Side Opening, Plastic. Available in size 9, 15, and 25 only.
- N - Push-on Fastener, for 90° Mounting Brackets.
- **F - Ferrite inductor.
- **Q - Ferrite inductor for use with Push-on Fastener and 90° Mounting Brackets.



Contact Technical Sales for details.

EURO-D SERIES

STEP	1	2	3	4	5	6	7	8	9
EXAMPLE	ED	25	F	42	R7	N	T2	0	

STEP 1 - BASIC SERIES

ED Series

STEP 2 - CONNECTOR VARIANTS

9, 15, 25, 29, 37, 50

STEP 3 - CONNECTOR GENDER

M - Male
F - Female

STEP 4 - CONTACT TERMINATION

- 2 - Solder cup.
- 36 - Solder, Straight Printed Board Mount with 0.236 [5.99] Tail Length.
- 42 - Solder, 90° Printed Board Mount with 0.370 [9.40] Contact Extension.
- 44 - Solder, Inverted 90° Printed Board Mount with 0.370 [9.40] Contact Extension.
- 52 - Solder, 90° Printed Board Mount with 0.370 [9.40] Contact Extension.

*STEP 5 - MOUNTING STYLE

Refer to MD Series Step 5

STEP 9 - SPECIAL OPTIONS

Contact Technical Sales

STEP 8 - Shell Options

- 0 - Zinc Plated, with Dichromate Seal.
- X - Tin Plated.
- Z - Tin Plated and Dimpled (male connectors only).

*STEP 7 - LOCKING AND POLARIZING SYSTEMS

Refer to MD Series Step 7

*STEP 6 - HOODS AND PUSH-ON FASTENERS

Refer to MD Series Step 6

*For additional information on accessories listed in steps 5, 6 and 7, see Accessory Catalog.

**Ferrite inductor is available on contact types 36 only.