

FAIRCHILD

A Schlumberger Company

IRF140-143/IRF540-543 T-39-13
N-Channel Power MOSFETs,
27 A, 60-100 V

Power And Discrete Division

Description

These devices are n-channel, enhancement mode, power MOSFETs designed especially for high power, high speed applications, such as switching power supplies, UPS, AC and DC motor controls, relay and solenoid drivers and high energy pulse circuits.

- Low $R_{DS(on)}$
- V_{GS} Rated at ± 20 V
- Silicon Gate for Fast Switching Speeds
- I_{DSS} , $V_{DS(on)}$, Specified at Elevated Temperature
- Rugged
- Low Drive Requirements
- Ease of Paralleling

TO-204AE

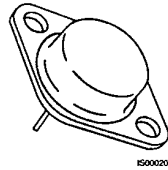

IRF140
 IRF141
 IRF142
 IRF143

TO-220AB

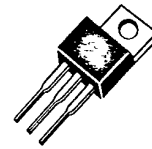

IRF540
 IRF541
 IRF542
 IRF543

Product Summary

Part Number	V_{DSS}	$R_{DS(on)}$	I_D at $T_C = 25^\circ C$	I_D at $T_C = 100^\circ C$	Case Style
IRF140	100 V	0.085 Ω	27 A	17 A	TO-204AE
IRF141	60 V	0.085 Ω	27 A	17 A	
IRF142	100 V	0.11 Ω	24 A	15 A	
IRF143	60 V	0.11 Ω	24 A	15 A	
IRF540	100 V	0.085 Ω	27 A	17 A	TO-220AB
IRF541	60 V	0.085 Ω	27 A	17 A	
IRF542	100 V	0.11 Ω	24 A	15 A	
IRF543	60 V	0.11 Ω	24 A	15 A	

Notes

For information concerning connection diagram and package outline, refer to Section 7.

IRF140-143/IRF540-543

T-39-13

Maximum Ratings

Symbol	Characteristic	Rating IRF140/142 IRF540/542	Rating IRF141/143 IRF541/543	Unit
V _{DSS}	Drain to Source Voltage ¹	100	60	V
V _{DGR}	Drain to Gate Voltage ¹ R _{GS} = 20 kΩ	100	60	V
V _{GS}	Gate to Source Voltage	± 20	± 20	V
T _J , T _{stg}	Operating Junction and Storage Temperatures	-55 to +150	-55 to +150	°C
T _L	Maximum Lead Temperature for Soldering Purposes, 1/8" From Case for 5 s	275	275	°C

Maximum Thermal Characteristics

		IRF140-143	IRF540-543	
R _{θJC}	Thermal Resistance, Junction to Case	1.0	1.0	°C/W
P _D	Total Power Dissipation at T _C = 25°C	125	125	W
I _{DM}	Pulsed Drain Current ²	108	108	A

Electrical Characteristics (T_C = 25°C unless otherwise noted)

Symbol	Characteristic	Min	Max	Unit	Test Conditions
Off Characteristics					
V _{(BR)DSS}	Drain Source Breakdown Voltage ¹ IRF140/142/540/542 IRF141/143/541/543	100		V	V _{GS} = 0 V, I _D = 250 μA
		60			
I _{DSS}	Zero Gate Voltage Drain Current		250	μA	V _{DS} = Rated V _{DSS} , V _{GS} = 0 V
			1000	μA	V _{DS} = 0.8 x Rated V _{DSS} , V _{GS} = 0 V, T _C = 125°C
I _{GSS}	Gate-Body Leakage Current IRF140-143 IRF540-543		± 100	nA	V _{GS} = ± 20 V, V _{DS} = 0 V
			± 500		
On Characteristics					
V _{GS(th)}	Gate Threshold Voltage	2.0	4.0	V	I _D = 250 μA, V _{DS} = V _{GS}
R _{DS(on)}	Static Drain-Source On-Resistance ² IRF140/141/540/541 IRF142/143/542/543			Ω	V _{GS} = 10 V, I _D = 15 A
			0.085		
			0.11		
g _{fs}	Forward Transconductance	6.0		S (Ω)	V _{DS} = 10 V, I _D = 15 A

IRF140-143/IRF540-543

T-39-13

Electrical Characteristics (Cont.) ($T_C = 25^\circ\text{C}$ unless otherwise noted)

Symbol	Characteristic	Min	Max	Unit	Test Conditions
Dynamic Characteristics					
C_{iss}	Input Capacitance		1600	pF	$V_{DS} = 25\text{ V}$, $V_{GS} = 0\text{ V}$ $f = 1.0\text{ MHz}$
C_{oss}	Output Capacitance		800	pF	
C_{rss}	Reverse Transfer Capacitance		300	pF	
Switching Characteristics ($T_C = 25^\circ\text{C}$, Figures 1, 2) ³					
$t_{d(on)}$	Turn-On Delay Time		30	ns	$V_{DD} = 45\text{ V}$, $I_D = 15\text{ A}$ $V_{GS} = 10\text{ V}$, $R_{GEN} = 4.7\ \Omega$ $R_{GS} = 4.7\ \Omega$
t_r	Rise Time		60	ns	
$t_{d(off)}$	Turn-Off Delay Time		80	ns	
t_f	Fall Time		30	ns	
$t_{d(on)}$	Turn-On Delay Time		60	ns	$V_{DD} = 25\text{ V}$, $I_D = 15\text{ A}$ $V_{GS} = 10\text{ V}$, $R_{GEN} = 50\ \Omega$ $R_{GS} = 50\ \Omega$
t_r	Rise Time		450	ns	
$t_{d(off)}$	Turn-Off Delay Time		150	ns	
t_f	Fall Time		200	ns	
Q_g	Total Gate Charge		60	nC	$V_{GS} = 10\text{ V}$, $I_D = 34\text{ A}$ $V_{DD} = 35\text{ V}$

Symbol	Characteristic	Typ	Max	Unit	Test Conditions
Source-Drain Diode Characteristics					
V_{SD}	Diode Forward Voltage IRF140/141/540/541 IRF142/143/542/543	2.0	2.5	V	$I_S = 27\text{ A}$; $V_{GS} = 0\text{ V}$ $I_S = 24\text{ A}$; $V_{GS} = 0\text{ V}$
		2.0	2.3	V	
t_{rr}	Reverse Recovery Time	300		ns	$I_S = 4.0\text{ A}$; $di_S/dt = 25\text{ A}/\mu\text{S}$

Notes

- $T_J = +25^\circ\text{C}$ to $+150^\circ\text{C}$
- Pulse width limited by T_J
- Switching time measurements performed on LEM TR-58 test equipment.

Typical Electrical Characteristics

Figure 1 Switching Test Circuit

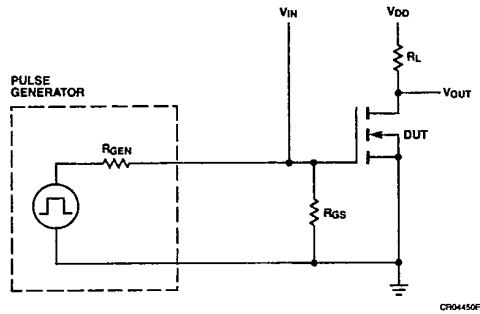

CR04450F

Figure 2 Switching Waveforms

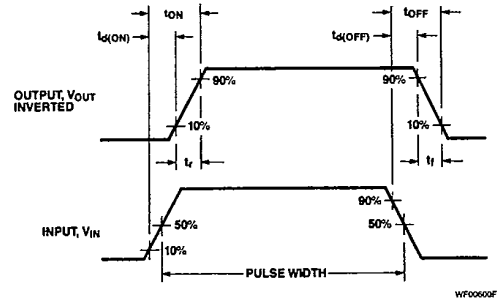

WF00600F

Typical Performance Curves

Figure 3 Output Characteristics

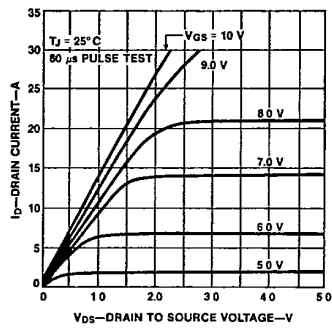

PC10040F

Figure 4 Static Drain to Source Resistance vs Drain Current

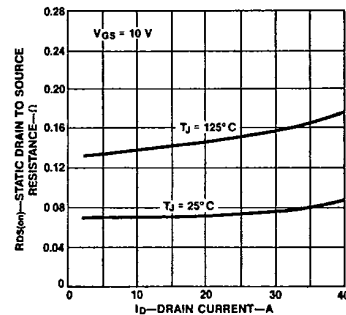

PC10050F

Figure 5 Transfer Characteristics

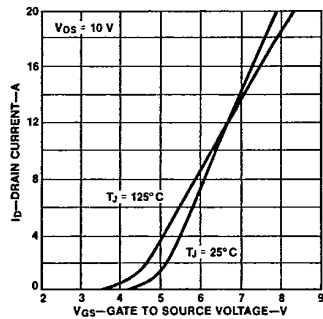

PC10060F

Figure 6 Temperature Variation of Gate to Source Threshold Voltage

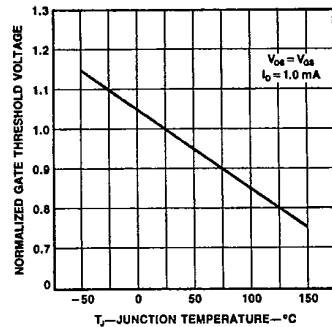

PC09841F

IRF140-143/IRF540-543

T-39-13

Typical Performance Curves (Cont.)

Figure 7 Capacitance vs Drain to Source Voltage

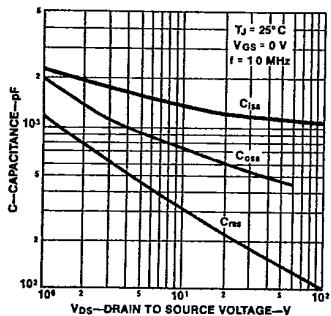

PC10070F

Figure 8 Gate to Source Voltage vs Total Gate Charge

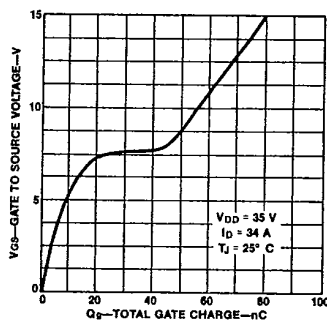

PC10080F

Figure 9 Forward Biased Safe Operating Area

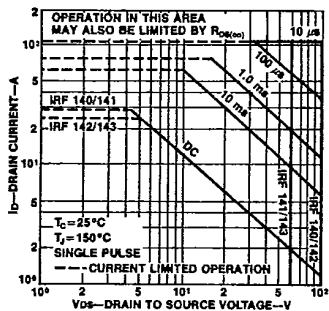

PC10090F

Figure 10 Transient Thermal Resistance vs Time

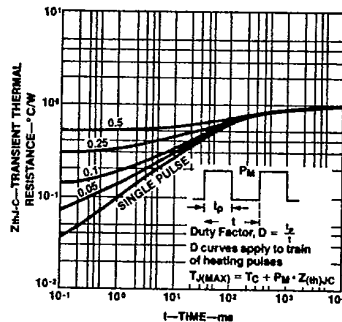

PC10100F